

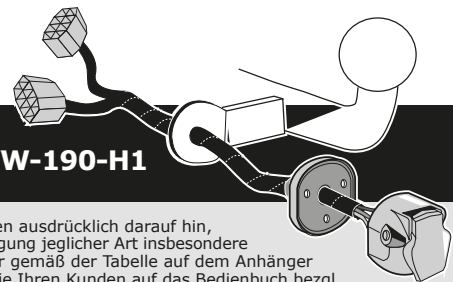

Audi A3 3-door/3-Türer 08/2012 >>
Audi A3 Sportback 02/2013 >>
Audi A3 Sportback e-tron 11/2014 >>
Audi A3 Sportback g-tron 02/2014 >>
Audi A3 Saloon/Limo 09/2013 >>
Audi A3 Cabriolet 03/2014 >>



For models with and without trailer preparation
Für Fahrzeuge mit und ohne Anhängervorbereitung

Partnr.: VW-190-H1

(DE)

• Einbauanleitung Elektrosatz Anhängervorrichtung mit 13-P Steckdose lt. DIN/ISO Norm 11446. • Wir weisen ausdrücklich darauf hin, dass eine unsachgemäße und nicht in einer Fachwerkstatt durchgeführte Montage einen Verzicht auf Entschädigung jeglicher Art insbesondere bezüglich des Produkthaftpflichtrechts zur Folge hat. • Technische Änderungen vorbehalten. • Widerstand nur gemäß der Tabelle auf dem Anhänger verwenden. • Achtung! Bitte lesen Sie vorab diese Anleitung, nehmen Sie diese zur Kenntnis und verweisen Sie Ihren Kunden auf das Bedienbuch bezgl. der eventuell zu treffenden Maßnahmen zum Ziehen eines Anhängers. • Bei Funktionsproblemen ist die Fehlersuche auf ca. 0,5 Stunden zu begrenzen, kontaktieren Sie die ECS Helpline: ts@ecs-electronics.nl / 00800 22552327

(FR)

• Instructions de montage du faisceau électrique pour crochet d'attelage conforme à la norme DIN/ISO 11446 prise 13-P. • Il est expressément prévu qu' on ne saurait se prévaloir d'un quelconque préjudice contractuel ou réhibitoire si le montage avait été fait en dépit des dites instructions ou dans un garage ne disposant pas des équipements adéquats. • Sous réserve de modifications techniques. • Ne excédez pas la charge maximale, indiquée dans le tableau. • Attention! Avant de commencer le branchement, on vous prie de prendre compte des connections à faire dans la notice, ainsi que communiquer directement à votre client les mesures à prendre pour tirer une remorque. • S'il y a des problèmes de fonctionnement, limiter la recherche de défauts à env. 30 minutes et contacter ECS l'Aide en ligne: ts@ecs-electronics.nl / 00800 22 55 23 27.

(NL)

• Montage-handleiding elektrokabelset voor trekhaak met 13-P contactdoos vlg. DIN/ISO norm 11446. • Wij wijzen er met nadruk op, dat ondeskundige en niet door een vakkundige werkplaats uitgevoerde montage tot gevolg heeft dat daardoor ieder recht op schadevergoeding, ook op wettelijke aansprakelijkheid inzake producten, vervalt. • Technische wijzigingen voorbehouden. • Gebruik alleen belasting volgens aansluittabel op het getrokken voertuig. • Opgelet! Wij verzoeken U dringend vooraf deze instructie door te nemen, hiervan kennis te nemen en uw cliënt te verwijzen naar het instructieboekje betreffende de eventueel te nemen maatregelen voor het trekken van een aanhangwagen. • Bij werkingsproblemen moet de foutencontrole tot ca. 0,5 uur beperkt worden, neem contact op met de ECS Helpline: ts@ecs-electronics.nl / 00800 22 55 23 27.

(GB)

• Fitting instructions electric wiring kit tow bar with 13-P socket up to DIN/ISO Norm 11446. • We would expressly point out that assembly not carried out properly by a competent installer will result in cancellation of any right to damage compensation, in particular those arising by virtue of the product liability act. • Contents of these kits and their fitting manuals are subject to alteration without notice, please ensure that these instructions are read and fully understood before commencing installation. • Do not overload circuits; the maximum loads per connection are detailed in this manual. • Attention! Before Installation, please read this manual carefully and inform your customer to consult the vehicle owners manual to check for any vehicle modifications required before towing. • In the event of functional problems, troubleshooting must be limited to about 0.5 hours, contact the ECS Helpline: ts@ecs-electronics.nl / 00800 22 55 23 27.

(ES)

• Instrucciones de montaje de kit eléctrico para enganche de remolque con caja de conexiones 13-P según norma DIN/ISO 11446. • El montaje inapropiado y efectuado por personal no cualificado originará la pérdida de todo derecho a indemnización o la expiración de toda responsabilidad civil con respecto al producto. • Nos reservamos el derecho a efectuar modificaciones técnicas. • Utilice sólo cargas de acuerdo a la tabla de conexión del vehículo remolcado. • Atención: lea atentamente este manual antes de la instalación e informe al cliente que debe consultar el manual de usuario del vehículo para conocer cualquier modificación realizada. • En caso de tener problemas con su funcionamiento, la búsqueda de errores está limitada a aprox. 0,5 horas, por lo que le recomendamos ponerse en contacto con el servicio de atención telefónica: ts@ecs-electronics.nl / 00800 22 55 23 27.

(IT)

• Istruzioni di montaggio di set di cavi elettrici per gancio da traino con zoccolo a 13-P conforme alla norma DIN/ISO 11446. • Sottolineiamo espressamente che un montaggio inadeguato ed eseguito da un'officina non specializzata ha come conseguenza il decadere di qualsiasi diritto al risarcimento danni, nonché alla responsabilità legale relativa ai prodotti. • Ci si riserva il diritto di apportare modifiche tecniche. • Utilizzare esclusivamente un carico conforme alla tabella degli allacci relativa al veicolo in questione. • Attenzione! Vi invitiamo a leggere attentamente questo manuale e a invitare a vostra volta i clienti a leggere il manuale del conducente sulle eventuali misure da prendere per l'attacco di un rimorchio. • In caso di problemi di funzionamento, la ricerca di errori dovrebbe essere limitata a circa 0,5 ore. Contattare il centralino di assistenza per i fasci di cavi: ts@ecs-electronics.nl / 00800 22 55 23 27.

(SE)

• Monteringsanvisningar elkabelsats för dragkrok med 13-P kontaktdosa enligt DIN/ISO norm 11446. • Vi påpekar med eftertryck att all rätt till skadeersättning och all laglig ansvarighet förfaller om monteringen inte har utförts på rätt sätt och av en professionell verkstad. • Tekniska ändringar förbehålles. • Använd endast belastning enligt anslutningstabellen på det dragna fordonet. • Varning! Innan installation, läs den här handboken noga och informera din kund om att läsa fordonets användarhandbok för att undersöka vilka eventuella ändringar som behöver göras på fordonet. • Vid funtionsproblem ska felsökningen begränsas till ca 0,5 timme, kontakta reservdels-helpline ts@ecs-electronics.nl / 00800 22 55 23 27.

(CZ)

• Montážní pokyny: souprava pro elektrické propojení tažné tyče s 13-P zásuvkou do normy DIN/ISO 11446. • Výslovně zdůrazňujeme, že jakákoli montáž, která není provedená ve specializované dílně, má za následek odvolání nároků na kompenzaci jakéhokoli druhu, obzvláště vyplývajících ze zákona o odpovědnosti za způsobené škody. • Změny mohou být provedeny bez oznámení. • Používejte pouze při maximálním nabití podle tabulky na tažném vozidle. • Upozornění! Prosíme, abyste si nejdříve přečetli tyto instrukce, seznámili se s nimi a odkázali své zákazníky na příručku týkající se případných opatření, která musí být přijata pro tažení přívěsu. • Při problémech funkčnosti je třeba vyhledávání chyb omezit na cca 0,5 hodiny, kontaktujte ECS Helpline: ts@ecs-electronics.nl / 00800 22 55 23 27.

(DK)

• Monteringsvejledninger for det elektriske ledningsføringssæt for trækstang med 13-P stikdåse, DIN/ISO, norm 11446. • Vi ønsker at gøre udtrykkeligt opmærksom på atforkert samling, der ikke er udført af et specialiseret værksted, resulterer i bortfaldelse af kompenseringskrav af alle slags, i særdeles krav der måtte opstå omkring det lovligtige ansvar. • Kan ændres uden varsel. • Brug kun den maksimale belastning, i overensstemmelse med forbindelsestabelen for bugserede køretøjer. • OBS! For installation skal denne vejledning læses omhyggeligt og din kunde skal informeres om at kigge i køretøjets håndbog for at kontrollere om der skal laves eventuelle ændringer på køretøjet inden bugsering. • Ved funktionsproblemer skal fejlsøgningen begrænses til ca. 0,5 time, kontakt ECS Helpline: ts@ecs-electronics.nl / 00800 22 55 23 27.

(FI)

• Ohjeet vetokoukun sähkökaapelisarjan asentamiseen, jossa on DIN/ISO 11446 mukainen 13-P liitin. • Korostamme, että kaikki oikeudet vahinkokorvaukseen kuten myös valmistajan laillinen vastuu raukeavat, mikäli asennusta ei ole toteutettu oikealla tavalla eikä ammattitaitoisen asiantuntijan toimesta. • Oikeus teknisiin muutoksiin ilman erillistä huomautusta pidätetään. • Huomio! Lue tämä käyttöoppas huolellisesti ennen asennusta ja tiedota asiakkaita tarkistamaan kaikki ajoneuvon muutoksen ajoneuvon omistajan käyttöoppaas ennen hinausta. • Kuormita työvirtapiiriä ainoastaan hinattavan ajoneuvon kytkentäkaavan mukaisesti. • Virhehaku on rajoitettava toiminto-ongelmien esiintyessä noin 0,5 tuntiin, ota yhteys ECS Helpline: ts@ecs-electronics.nl / 00800 22 55 23 27.

(GR)

• Οδηγίες συναρμολόγησης ηλεκτρικού σετ καλωδίων μπάρας ρυμούλκησης με υποδοχή 13-P μέχρι DIN/ISO Κανόνας 11446. • Επισημαίνουμε κατηγορηματικά ότι οποιαδήποτε ασφαλή συναρμολόγηση, η οποία δεν έχει πραγματοποιηθεί ειδικό εργαστήριο θα οδηγήσει σε αποποίηση των αξιόσων επιβολής αποζημιώσεων οποιοδήποτε είδους, ειδικά όσα προκύπτουν από το νόμο ευθύνης προϊόντων. • Μπορεί να τροποποιηθεί χωρίς προηγούμενη ειδοποίηση. • Χρησιμοποιείτε μόνο μέγιστο ηλεκτρικό φορτίο σύμφωνα με τον πίνακα σύνδεσης στο ρυμούλκούμενο όχημα. • Προσοχή! Πριν την εγκατάσταση, διαβάστε το εγχειρίδιο αυτό προσεκτικά και ενημερώστε τον πελάτη σας να συμβουλευτεί το εγχειρίδιο ιδιοκτητών οχήματος ώστε να ελέγξει τυχόν τροποποιήσεις που απαιτούνται στο όχημα πριν τη ρυμούλκηση. • Σε περίπτωση προβλημάτων λειτουργίας να περιοριστεί η αναζήτηση σφαλμάτων σε περί. 0,5 δευτ., επικοινωνήστε με τη γραμμή υποστήριξης ECS Helpline: ts@ecs-electronics.nl / 00800 22 55 23 27.

(NO)

• Monteringsanviser elkabelsett for trekkrok med 13-P koblingsboks ifølge DIN/ISO norm 11446. • Vi påpeker ettertrykkelig at all rett til skadeerstatning og rettslig ansvar forfaller dersom monteringen ikke er blitt utført på riktig måte og av et profesjonelt verksted. • Tekniske endringer forbeholdes. • Overskrid ikke grensene anviset i tilkoblingstabellen på tilhengeren eller det tilkoblede kjøretøyet. • OBS! Les denne bruksanvisningen nøye før installasjon. Be kunden om å rådføre seg med brukerhåndboken for kjøretøyeiere for å sjekke om kjøretøyet må modifiseres før tauing. • Ved funksjonsproblemer må feilsøket begrenses til ca. 0,5 timer, kontakt ECS Helpline: ts@ecs-electronics.nl / 00800 22 55 23 27.

(PL)

• Instrukcje montażu zestawu okablowania elektrycznego dysza holowniczego z 13-P stykowym gniazdem DIN/ISO 11446. • Chcielibyśmy wyraźnie zaznaczyć, iż wszelki nieprawidłowy montaż, który nie jest wykonywany w specjalistycznym warsztacie pociąga za sobą utratę możliwości dochodzenia wszelkiego typu roszczeń, w szczególności tych wynikających z odpowiedzialności producenta za swój produkt. • Podlega zmianom bez powiadomienia. • Używać tylko takiego maksymalnego obciążenia które wynika z tabliczki połączeń holowanego pojazdu. • Uwaga! Przed zainstalowaniem należy dokładnie przeczytać tę instrukcję i poinformować klienta o konieczności sprawdzenia w instrukcji posiadacza pojazdu w celu sprawdzenia przed holowaniem, czy nie wprowadzono do pojazdu jakichkolwiek zmian. • W przypadku problemów ograniczyć wyszukiwanie błędów do ok. 0,5 godziny, skontaktować się z linią serwisową ts@ecs-electronics.nl / 00800 22 55 23 27.

Einzelteilliste

Liste de pieces

Onderdelenlijst

Part list

Lista de componentes

Elenco componenti

Dellista

Seznam dílů

Del-liste

Osaluettelo

Κατάλογος εξαρτημάτων

Delliste

Lista części

(DE)

(FR)

(NL)

(GB)

(ES)

(IT)

(SE)

(CZ)

(DK)

(FI)

(GR)

(NO)

(PL)

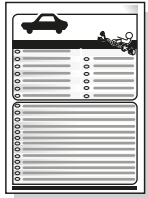
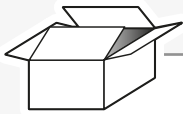

M1

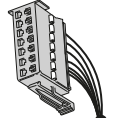

T

X

G

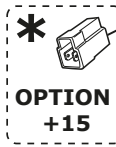

F2

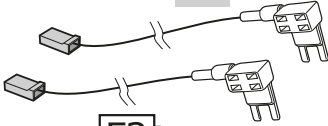

F3

A

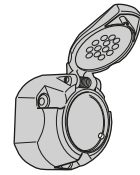
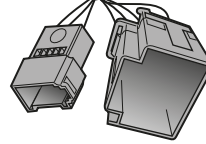

F1



B

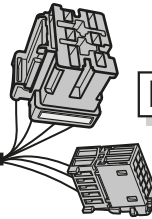

M



5x

L3



L2



L1

OPTION +15**

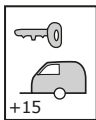

- (DE) Vorbereitung für +15
- (FR) Préparation pour +15
- (NL) Voorbereiding voor +15
- (GB) Preparation for +15
- (ES) Preparación para +15
- (IT) Preparazione per +15
- (SE) Förberedelse för +15
- (CZ) Příprava pro +15
- (DK) Forberedelse for +15
- (FI) Valmistelu varten +15
- (GR) Προετοιμασία για +15
- (NO) Forberedelse på +15
- (PL) Przygotowanie do +15

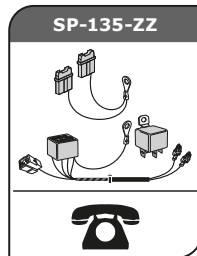

- (DE) Ergänzungssatz; fragen Sie Ihren Lieferanten.
- (FR) Set d'extension; consultez votre fournisseur
- (NL) Uitbreidingsset; raadpleeg uw leverancier
- (GB) Extension kit; consult your supplier
- (ES) Equipo de extensión; consulte con su proveedor
- (IT) Set di ampliamento; rivolgersi al proprio fornitore
- (SE) Förlängningssett; be leverantören om råd
- (CZ) Prodlužovací souprava; poraďte se s vaším dodavatelem
- (DK) Forlængelsesæt; henvend dig til din leverandør
- (FI) Lisäsarja; kysy neuvoa toimittajaltasi
- (GR) εξάρτηση επέκτασης; Συμβουλευθείτε τον προμηθευτή σας
- (NO) Påbyggingssett; forhør deg med din leverandør
- (PL) Zestaw rozszerzający; należy skonsultować się z dostawcą

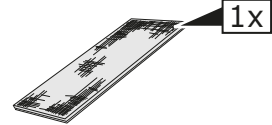
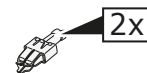
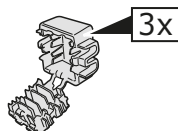
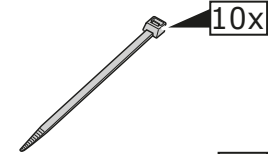
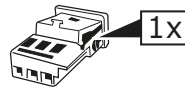
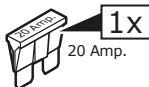
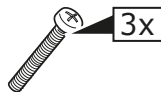

INFO

	BK	BN	BU	GY	GN	WH	YE	OG	PE	PI	RD	NL	BG	LG
DE	Schwarz	Braun	Blau	Grau	Grün	Weiß	Gelb	Orange	Violett	Rosa	Rot	Naturfarben	Beige	Hellgrün
FR	Noir	Marron	Bleu	Gris	Vert	Blanc	Jaune	Orange	Violet	Rose	Rouge	Nature	Beige	Vert Clair
NL	Zwart	Bruin	Blauw	Grijs	Groen	Wit	Geel	Oranje	Paars	Roze	Rood	Naturel	Beige	Licht Groen
GB	Black	Brown	Blue	Grey	Green	White	Yellow	Orange	Purple	Pink	Red	Natural colour	Beige	Light Green
ES	Negro	Marrón	Azul	Gris	Verde	Bianco	Amarillo	Naranja	Morado	Rosa	Rojo	Color natural	Beige	Verde Claro
IT	Nero	Marrone	Blu	Grigio	Verde	Bianco	Giallo	Arancione	Viola	Rosa	Rosso	Colori naturali	Beige	Verde Chiaro
SE	Svart	Brun	Blå	Grå	Grön	Vit	Gul	Orange	Lila	Rosa	Röd	Naturfärger	Beige	Ljusgrön
CZ	Černá	Hnědá	Modrá	Šedá	Zelená	Bílá	Žlutá	Oranžová	Fialová	Růžová	Červená	Přírodní	Béžový	světle zelená
DK	Sort	Brun	Blå	Grå	Grøn	Hvid	Gul	Orange	Lilla	Pink	Rød	Naturfarvet	Beige	lysegrøn
FI	Musta	Ruskea	Sininen	Harmaa	Vihreä	Valkoinen	Keltainen	Oranssi	Purppura	Vaaleanpunainen	Punainen	Luonnonväri	Beige	vaaleanvihreä
GR	Μαύο	Καφέ	Μπλε	Γκρι	Πράσινο	Λευκό	Κίτρινο	Πορτοκαλί	Μοβ	Ροζ	Κόκκινο	Φυσικά χρώματα	μπεζ	ανοιχτό πράσινο
NO	Svart	Brun	Blå	Grå	Grønn	Hvit	Gul	Oransje	Lilla	Rosa	Rød	Naturfarger	Beige	lysegrønn
PL	Czarny	Brązowy	Niebieski	Szary	Zielony	Biały	Żółty	Pomarańczowy	Purpurowy	Różowy	Czerwony	Barwy	beżowy	jasnozielony

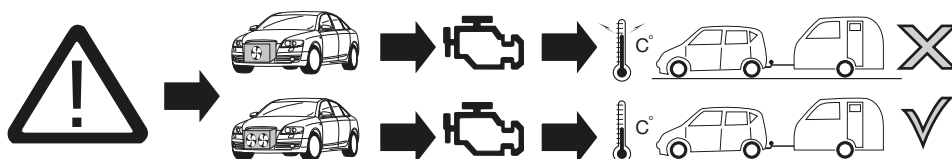
1

ACHTUNG!

DE

Die Kühlerleistung des Fahrzeuges muß bei Nachrüstung einer Anhängerkupplung möglicherweise erhöht werden! Bitte unbedingt Herstellerangaben beachten!!

ATTENTION!

FR

Il peut s'avérer nécessaire d'augmenter la puissance du radiateur du véhicule lorsque celui est équipé ultérieurement d'un attelage remorque! Respecter impérativement les instructions du constructeur!!

ATTENTIE!

NL

Het koelvermogen van het voertuig moet mogelijk worden verhoogd als achteraf een aanhangerkoppeling wordt aangebracht! Absoluut de fabrieksopgaven in acht nemen a.u.b.!!

ATTENTION!

GB

The vehicle's cooling capacity may have to be increased when retrofitting a trailer coupling! You must observe the manufacturer's instructions!!

¡ATENCIÓN!

ES

¡Es posible que haya que aumentar la capacidad del radiador en caso de reequipar un acoplamiento de remolque! ¡iRogamos tener en cuenta las instrucciones de fabricante sin falta!

ATTENZIONE!

IT

La capacità di raffreddamento del veicolo, quando si applica un gancio di traino, si deve possibilmente aumentare! Si prega di osservare tassativamente le indicazioni del produttore!!

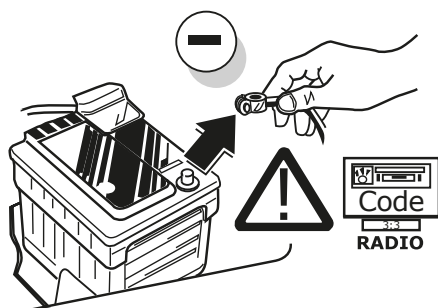

DE

Um Störungen und Schäden am Bordnetz zu vermeiden, muss die Massepolklemme unbedingt vor Beginn aller Arbeiten von der Fahrzeugbatterie getrennt werden! Insbesondere bei Arbeiten und Anschlüssen am CAN-Datenbus kann bei nicht abgeklemmter Batterie sowohl das Anhängermodul als auch das fahrzeugseitige Bordnetzsteuergerät beschädigt werden! Bitte Herstellervorschriften beim Ab- und Ankleben der Fahrzeugbatterie beachten!

FR

Afin d'éviter tout dys-fonctionnement ou endom-magement du circuit de bord, il est indispensable de débrancher la pince de masse de la batterie du véhicule avant le début de toute opération! En particulier s'il s'agit de travaux et de branchements effectués sur le bus de données CAN, si la batterie n'est pas débranchée, le module remorque aussi bien que le dispositif de commande de circuit de bord du véhicule risquent d'être endommagés! Veuillez respecter les directives du fabricant lors du branchement et du débranchement de la batterie du véhicule!

NL

Om storingen en schade aan de elektrische bedrading te vermijden moet de massapoolklem absoluut vóór aanvang van alle werkzaamheden worden losgekoppeld van de voertuigaccu! Vooral bij werkzaamheden aan en aansluitingen op de CAN-databus kan zowel de aanhangermodule als de voertuigzijdige regelenheid voor de elektrische installatie beschadigd worden, als de accu niet ontkoppeld is! Fabrieksvoorschriften bij het vast- en loskoppelen van de voertuigaccu in acht nemen a.u.b.!

GB

In order to avoid mal-functions and damage to the vehicle's electrical system the earth terminal must be disconnected from the vehicle's battery before starting work! Both the trailer module and the vehicle's control unit for the electrical system can be damaged during work on the CAN data bus connections if the battery is not disconnected! Please pay attention to the manufacturer's instructions when disconnecting and reconnecting the vehicle's battery!

ES

¡Para evitar fallos y defectos en el sistema eléctrico de a bordo es imprescindible separar al terminal de puesta a tierra de la batería del vehículo antes de realizar cualquier trabajo! ¡Particularmente al realizar trabajos y conexiones al bus de datos CAN puede estropearse tanto el módulo para remolques como el regulador del sistema eléctrico de a bordo del vehículo si no se ha desconectado la batería! ¡iRogamos observar las instrucciones del fabricante al conectar y desconectar la batería del vehículo!

IT

Per evitare disturbi e danni alla rete di distribuzione elettrica, l'espansione polare a massa deve essere assolutamente scollegata dalla batteria del veicolo prima dell'inizio dei lavori! In particolare durante i lavori e gli allacciamenti al bus di dati CAN, se la batteria non è scollegata si possono danneggiare sia la centralina rimorchio, sia la centralina della rete di distribuzione elettrica del veicolo! Attenersi alle indicazioni del costruttore per scollegare e ricollegare la batteria del veicolo!

ROUTING

A3 3-Doors
A3 Sportback
A3 Cabriolet

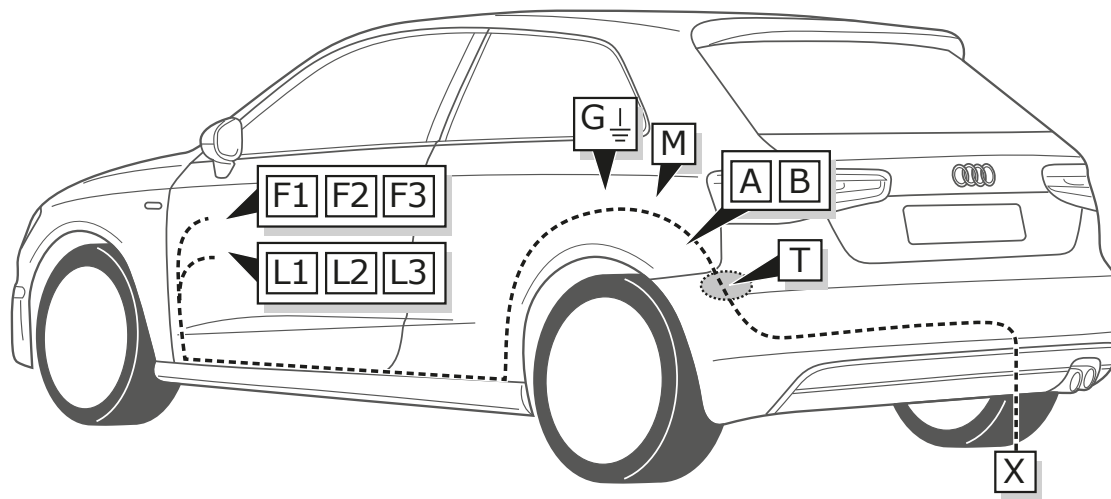

ROUTING

A3 Saloon

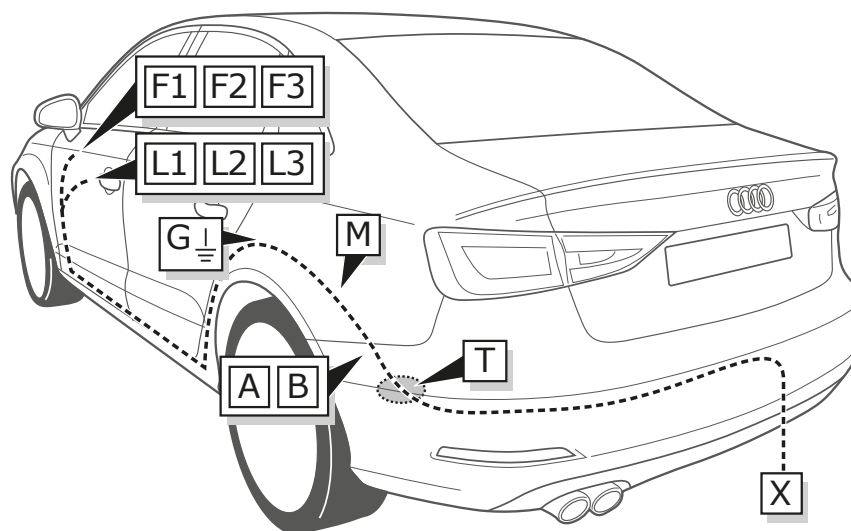

All models

2

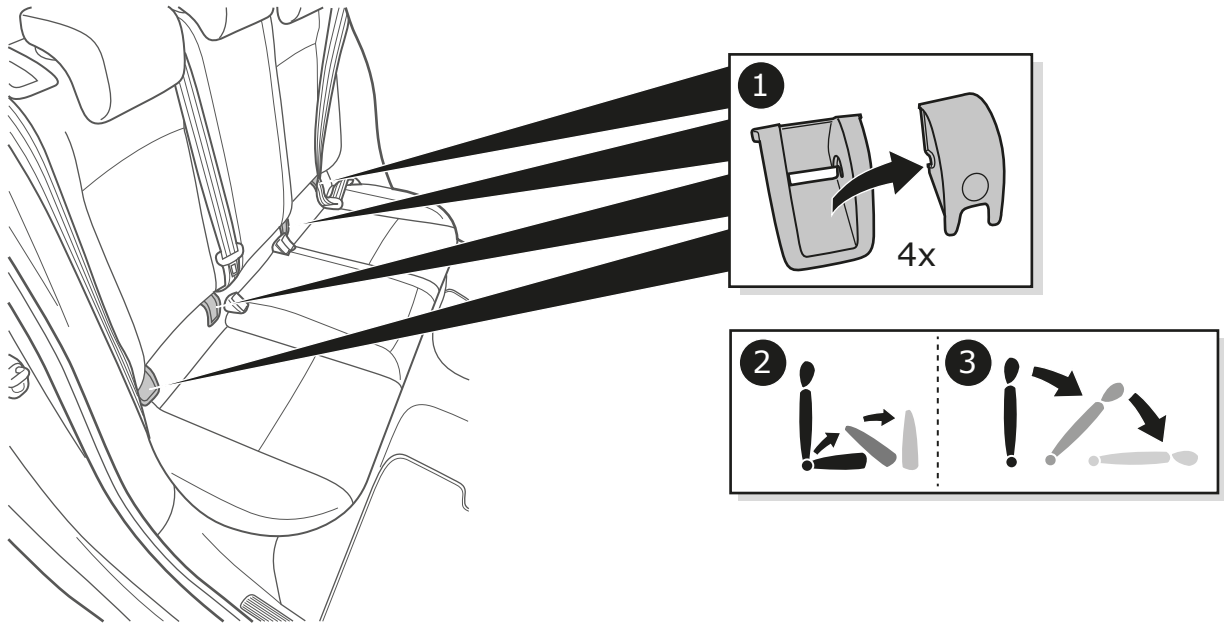

A3 3-Doors / Sportback / Saloon

3

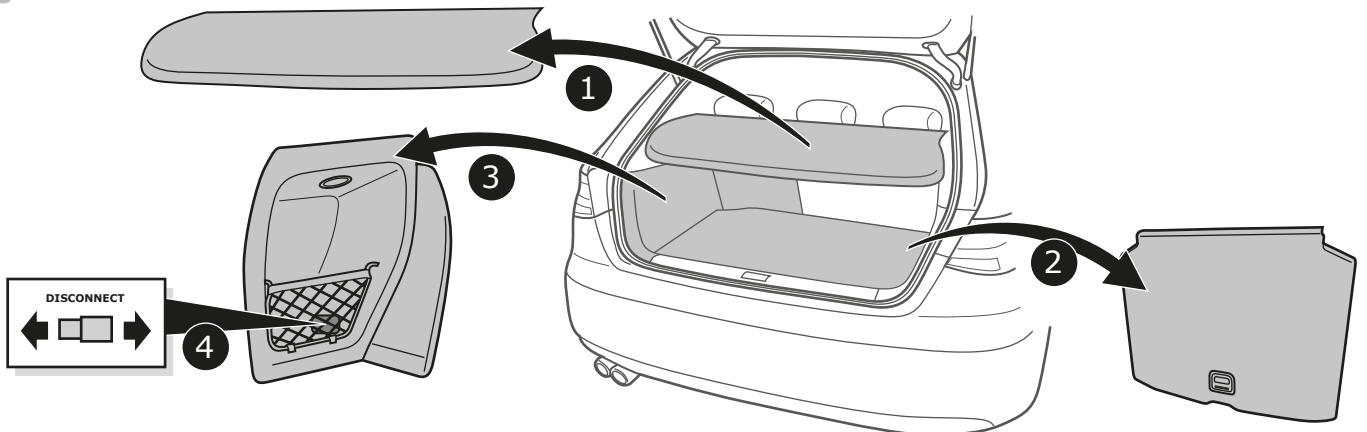

A3 Saloon

4

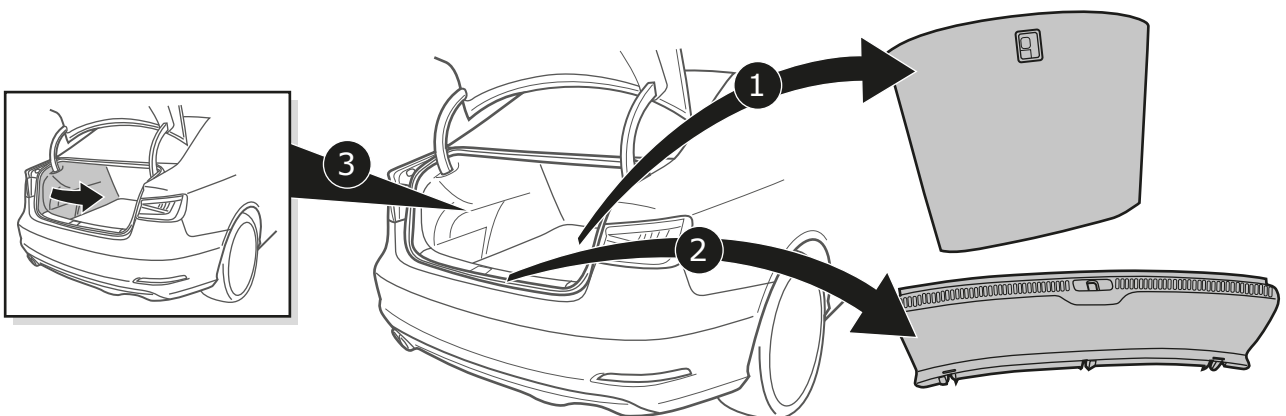

A3 Cabriolet

5

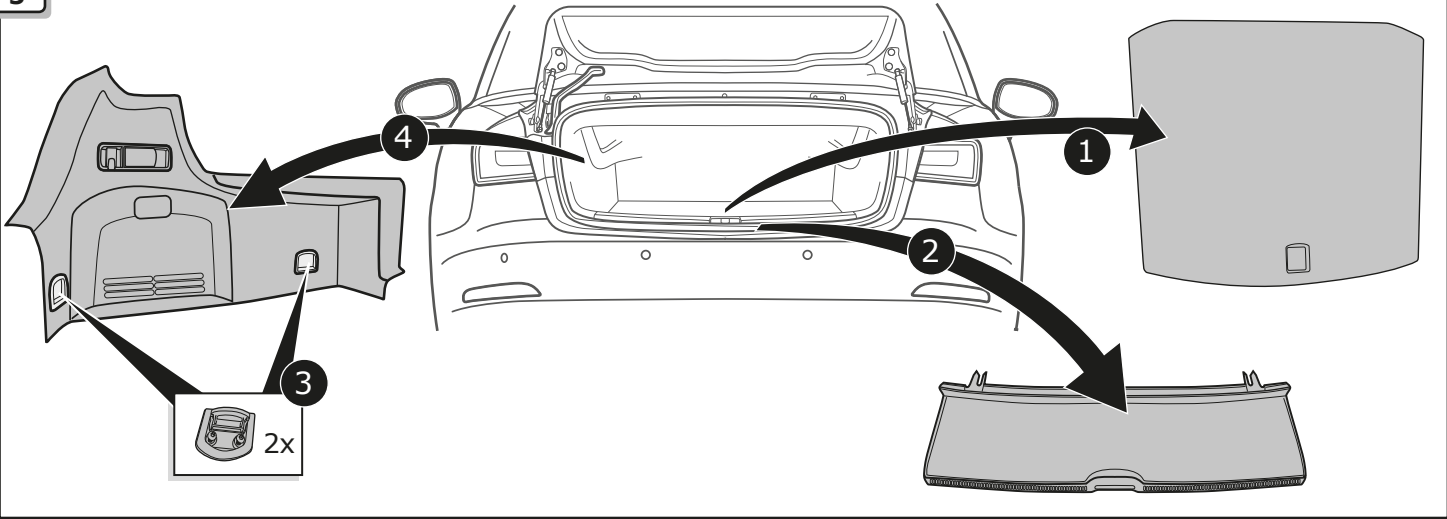

6

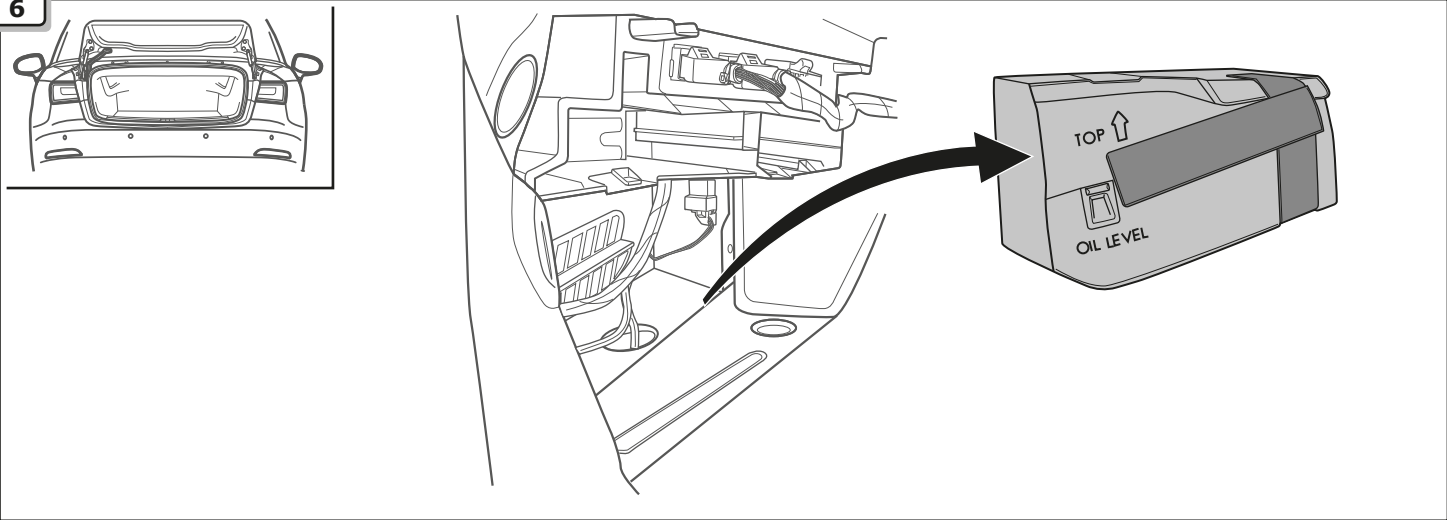

A3

7

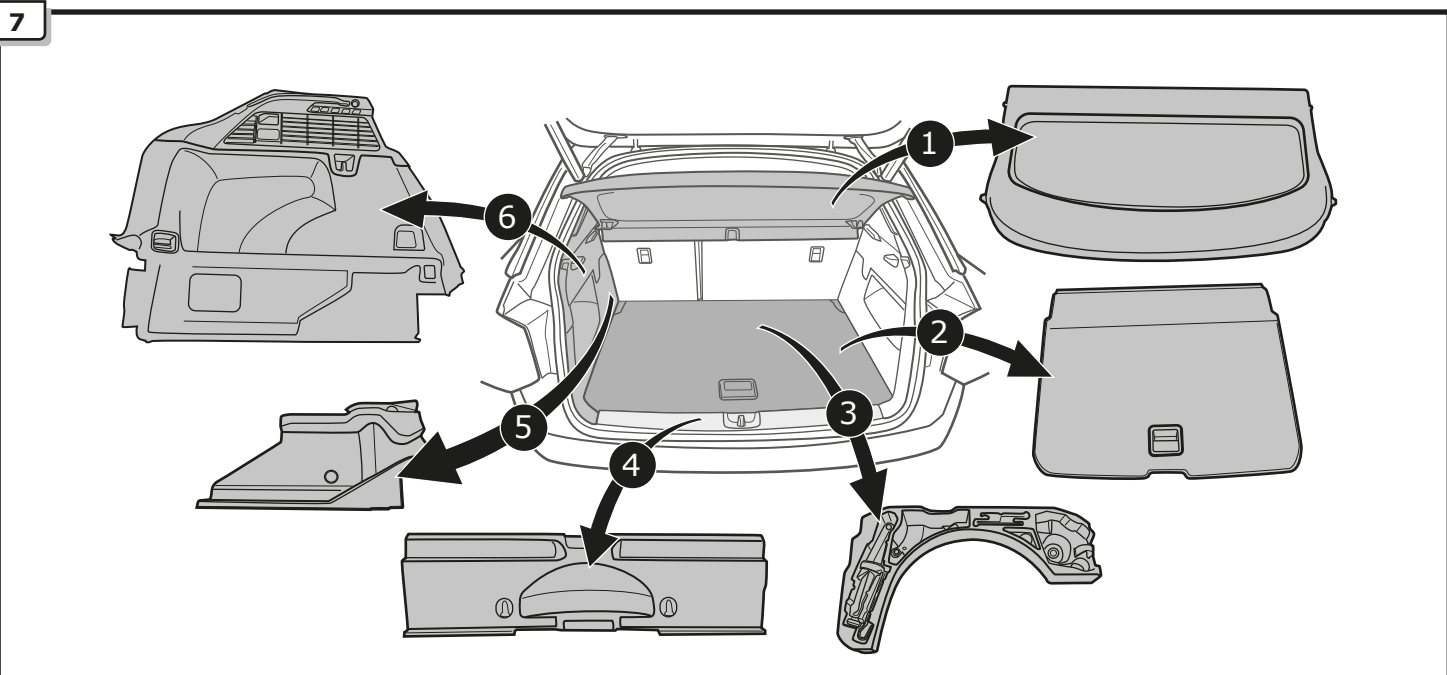

A3 Saloon

8

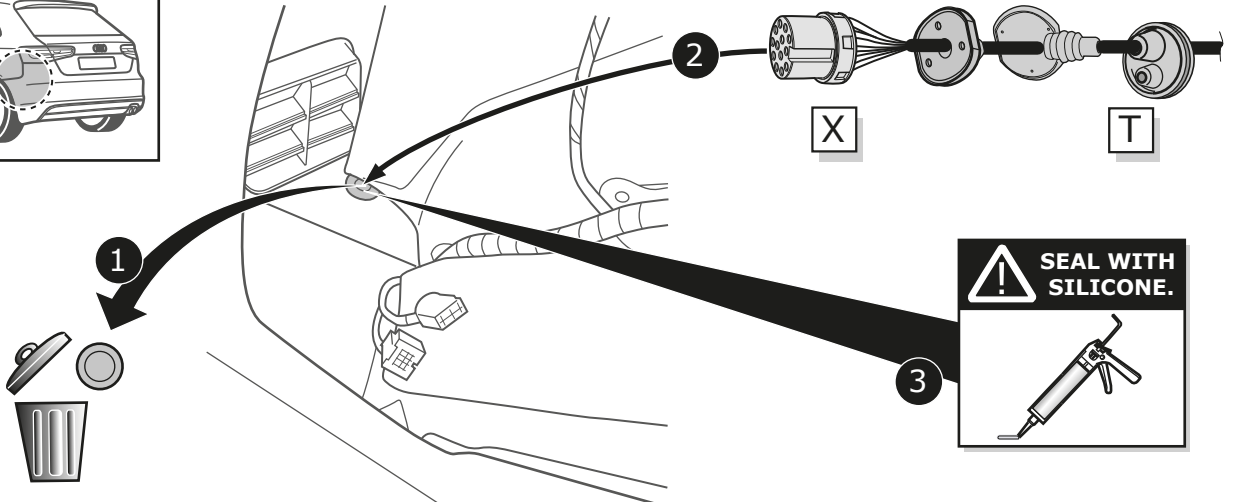
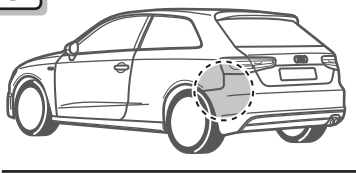

A3 Cabriolet

9

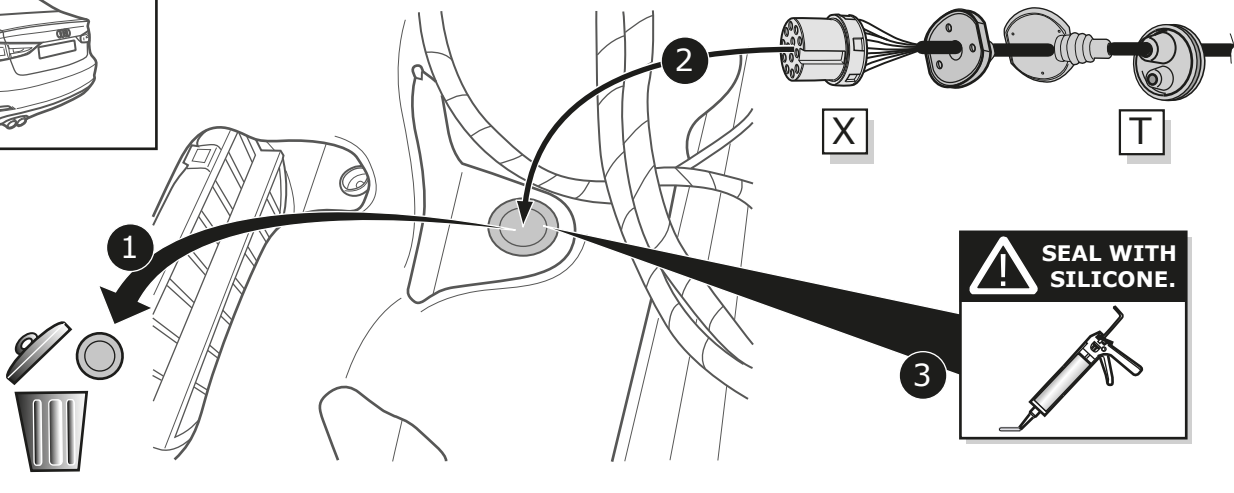
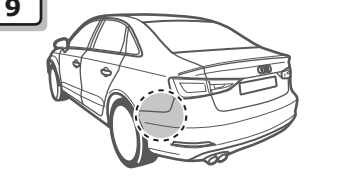

A3 3-Door/ Sportback

10

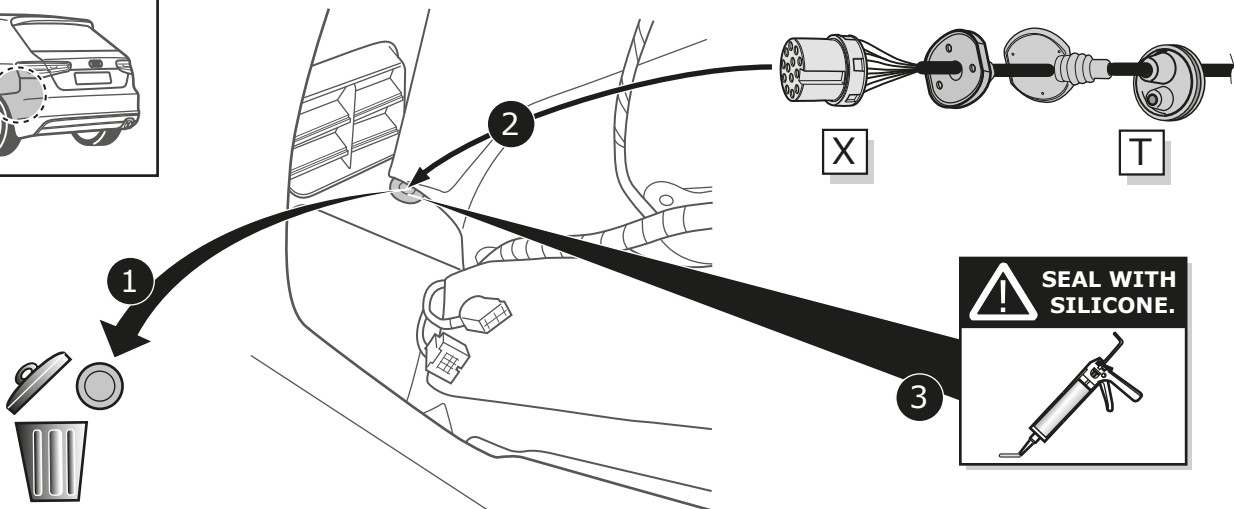
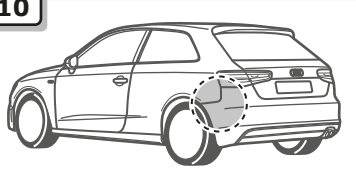

11

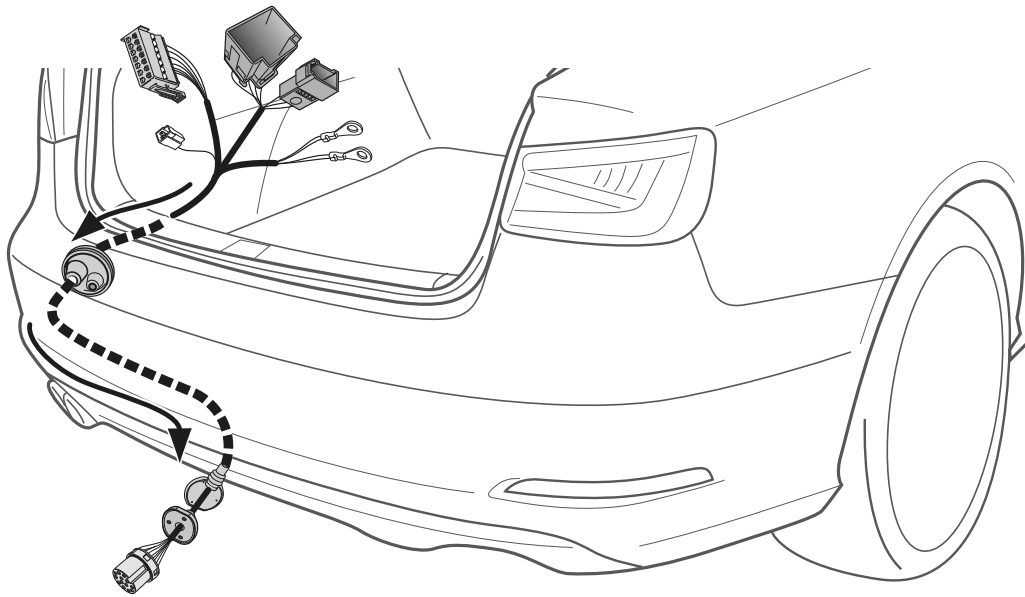

12

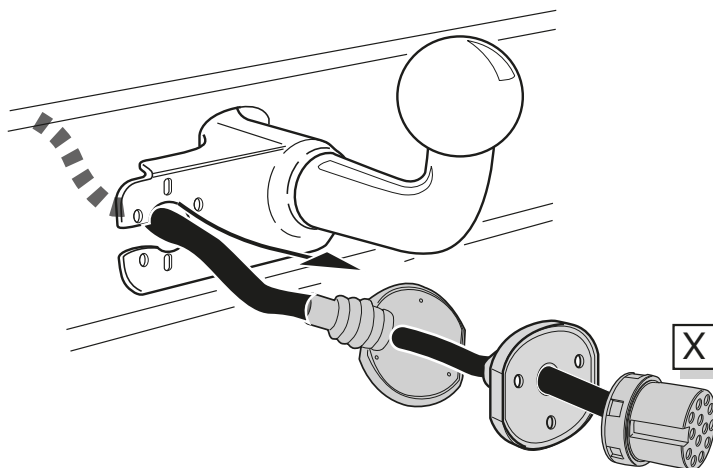

13

- Ⓓ Anschluss Steckdose
- Ⓕ Connection de la prise
- Ⓓ Contactdoos aansluiting
- Ⓖ Socket connection
- Ⓔ Conexión de la caja de enchufe
- Ⓘ Allaccio zoccolo



Page 30

14

Option 1

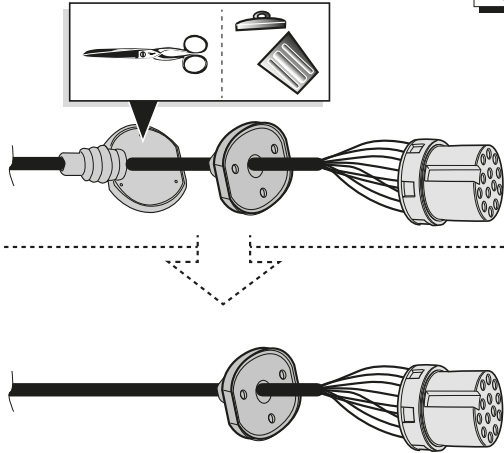

Option 2

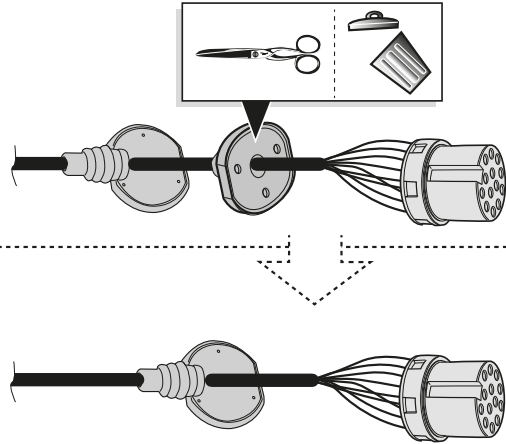

15

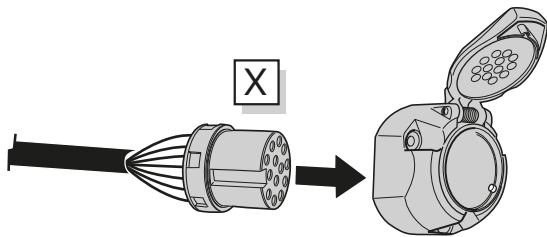

16

Option 1

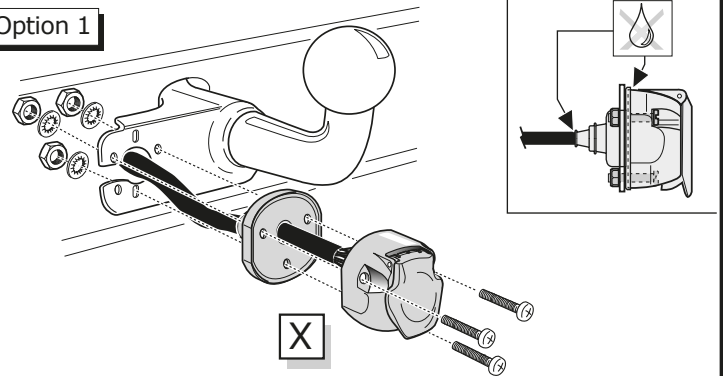

17

Option 2

1

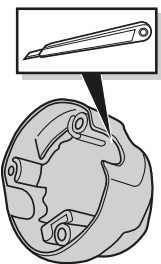

2

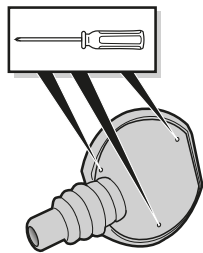

3

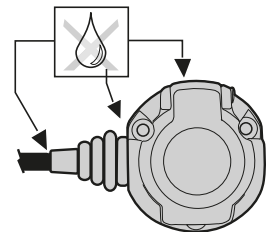
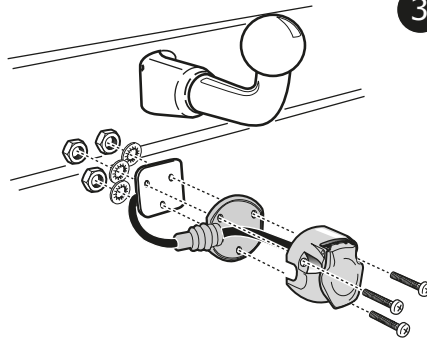

18

Option 2

1

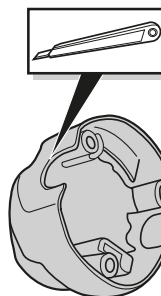

2

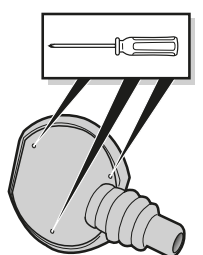

3

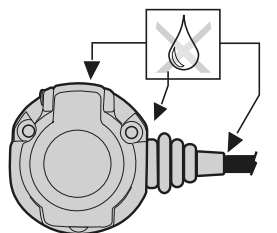
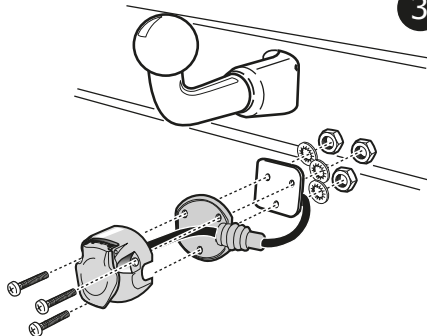

All models

19

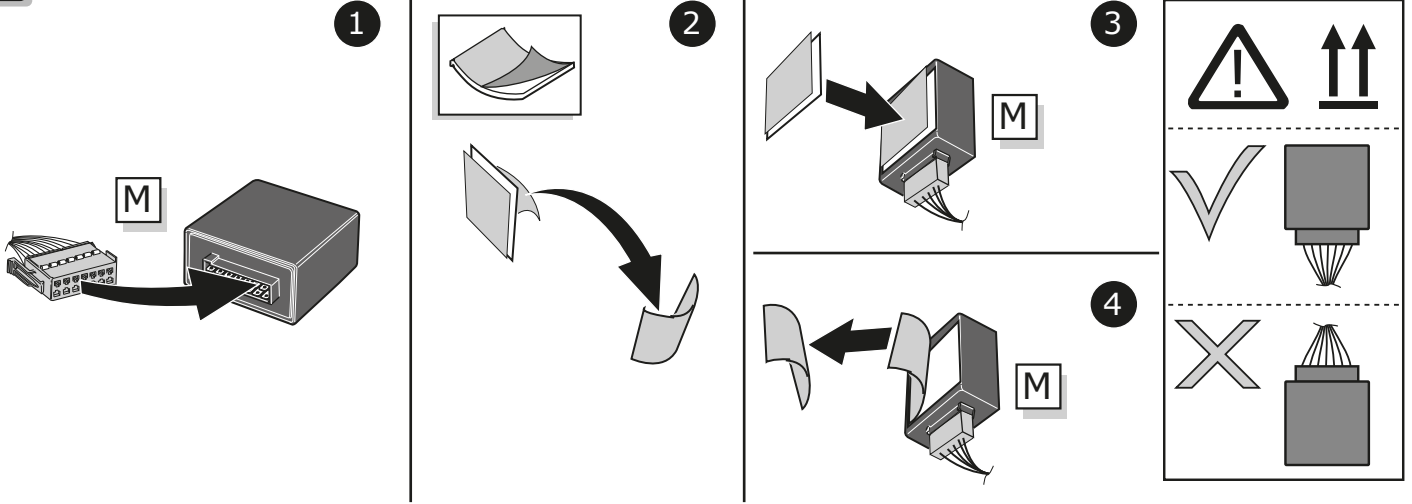

A3 3-Door/ Sportback

20

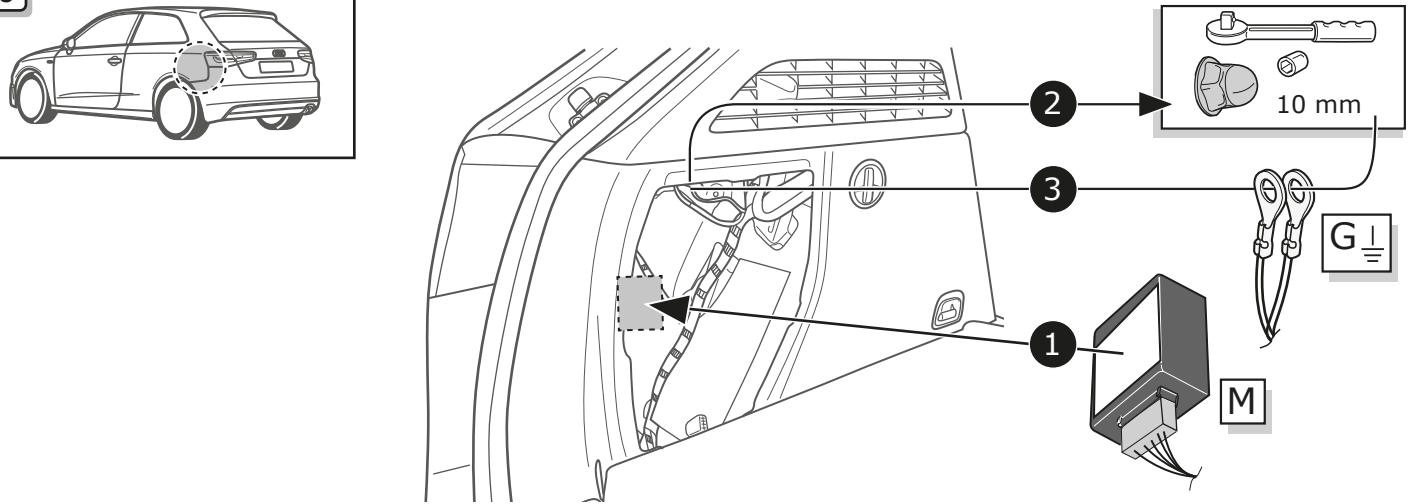

A3 Saloon

21

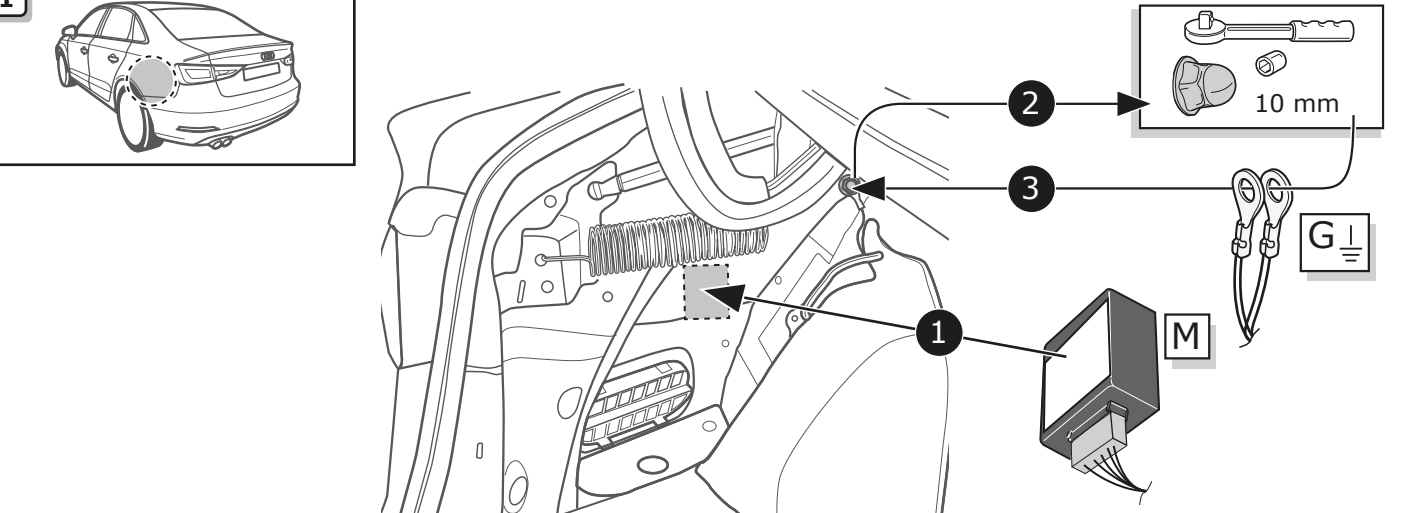

A3 Cabriolet

22

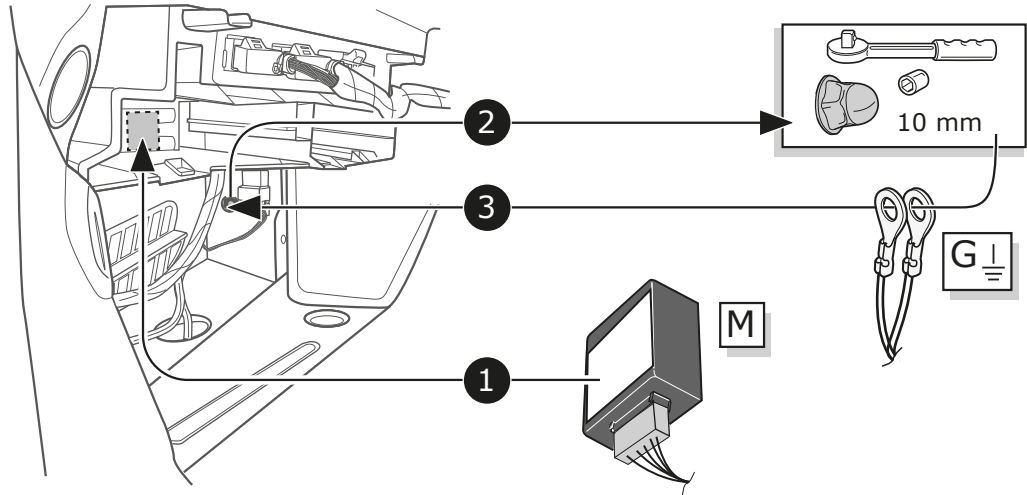
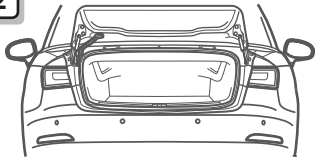

All models

23

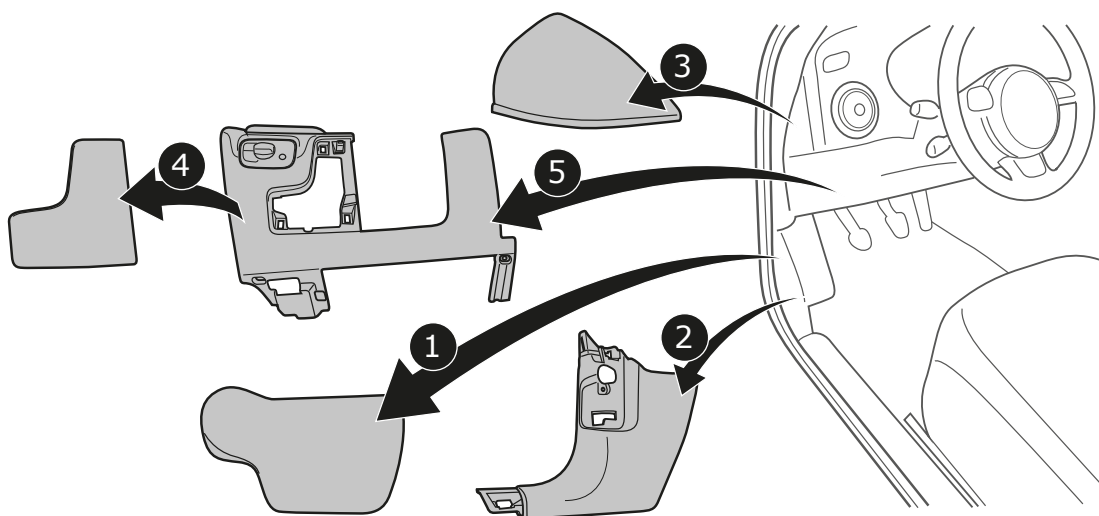

All models

24

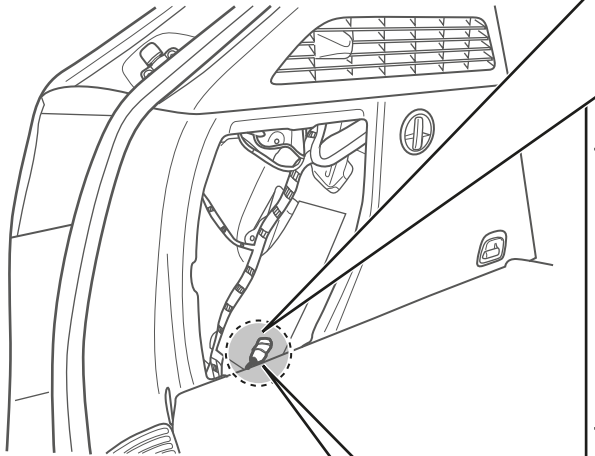

BK/PE
6 pin

BK
10 pin

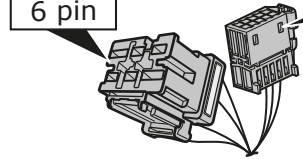

Vehicle **with** trailer preparation
Fahrzeuge **mit** Anhänger Vorbereitung



25 → 28

53 → 59



BK/PE
6 pin

BK
10 pin

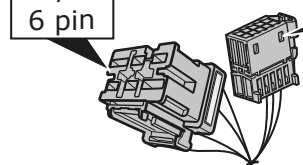

Vehicle **without** trailer preparation
Fahrzeuge **ohne** Anhänger Vorbereitung



29 → 59

Vehicle **with** trailer preparation / Fahrzeuge **mit** Anhänger Vorbereitung

25

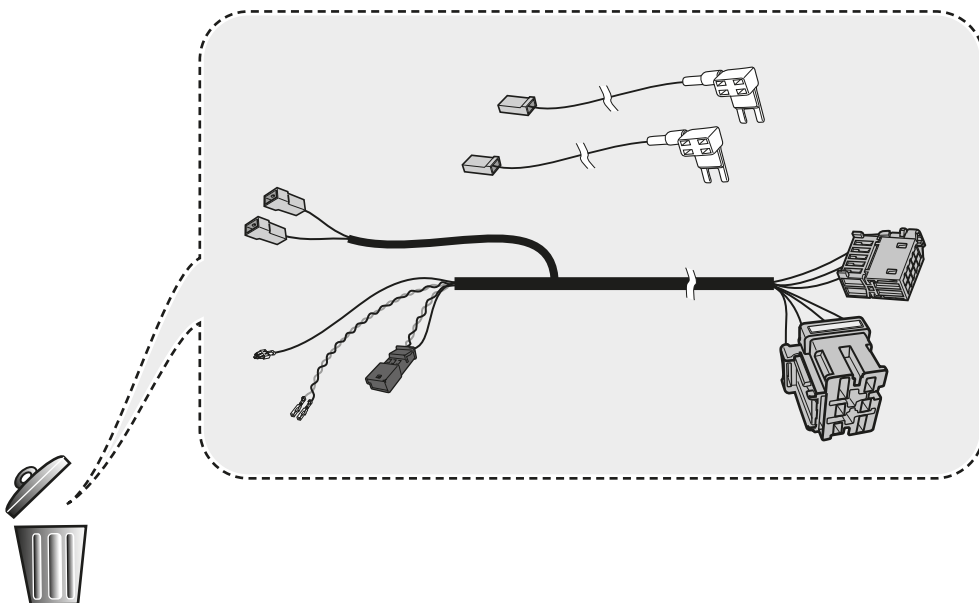

26

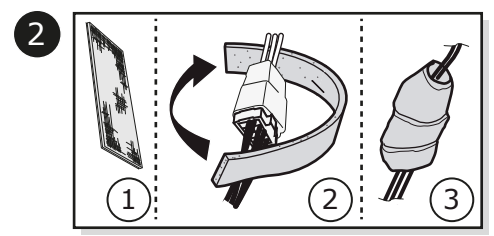
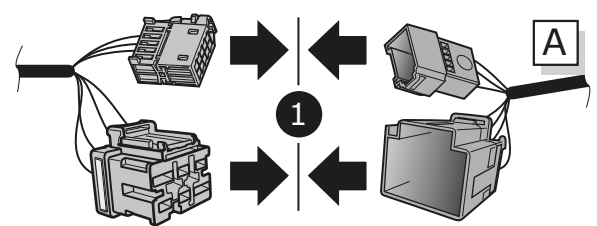
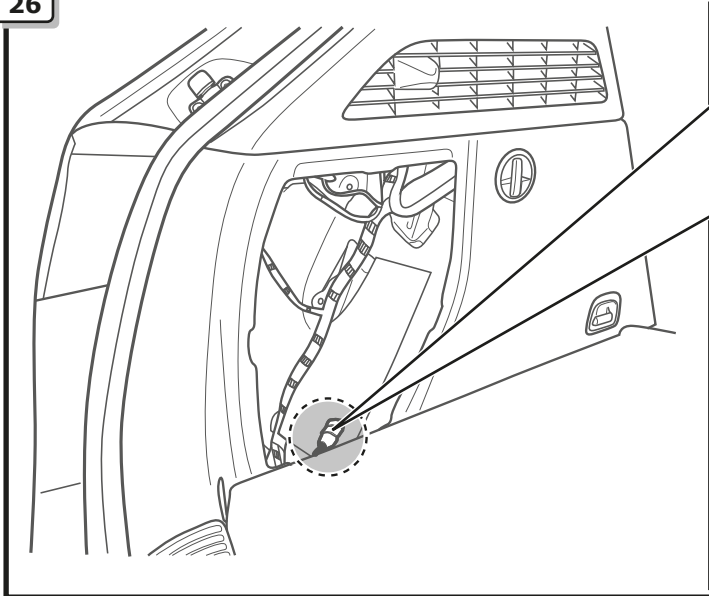

27

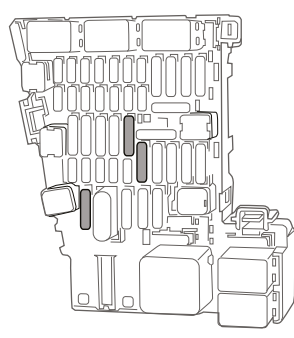
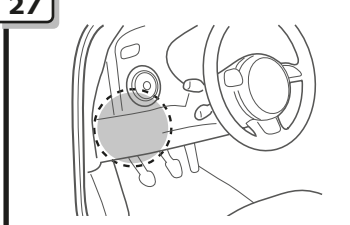

-> MY 2014

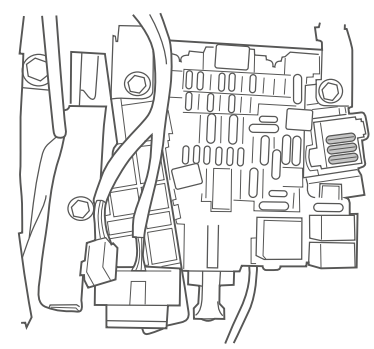

MY 2014 ->

28

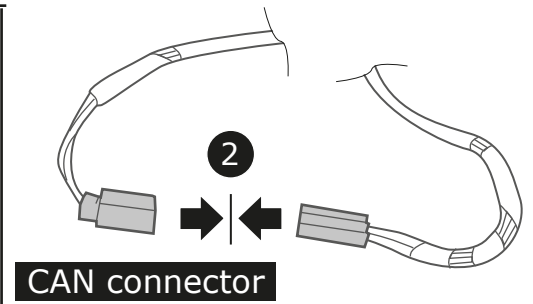
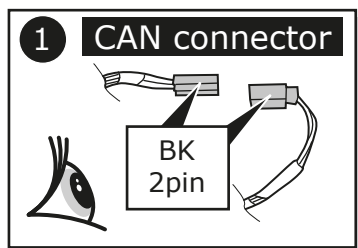
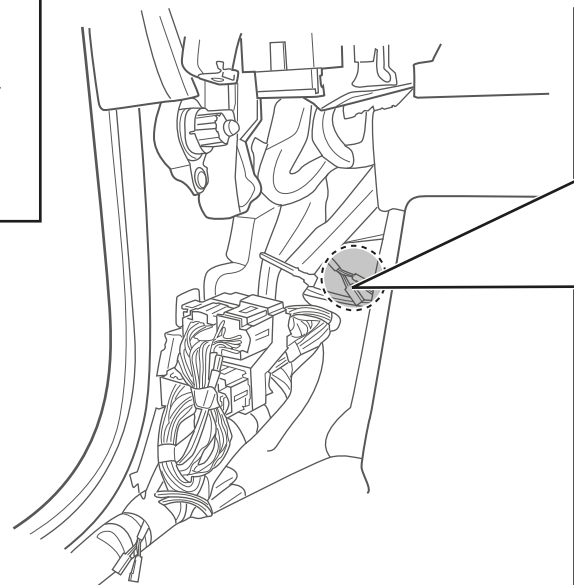
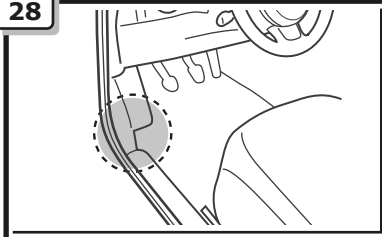

29

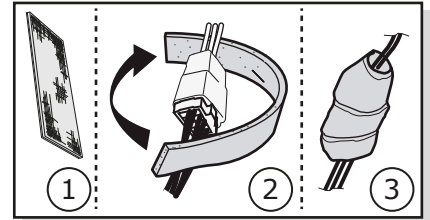
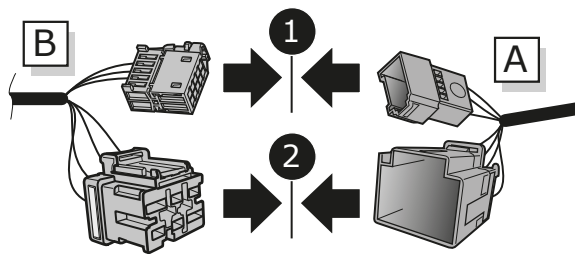
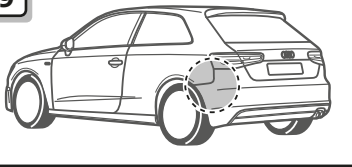

30

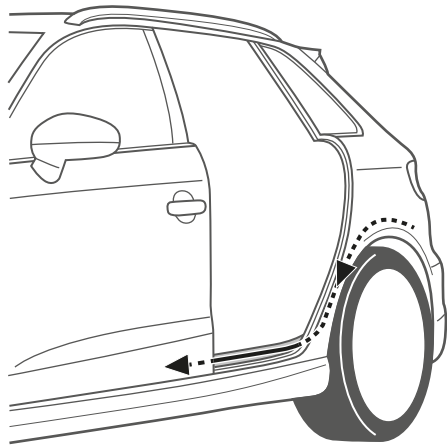

31

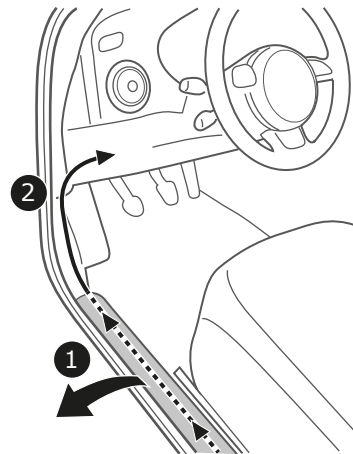

32

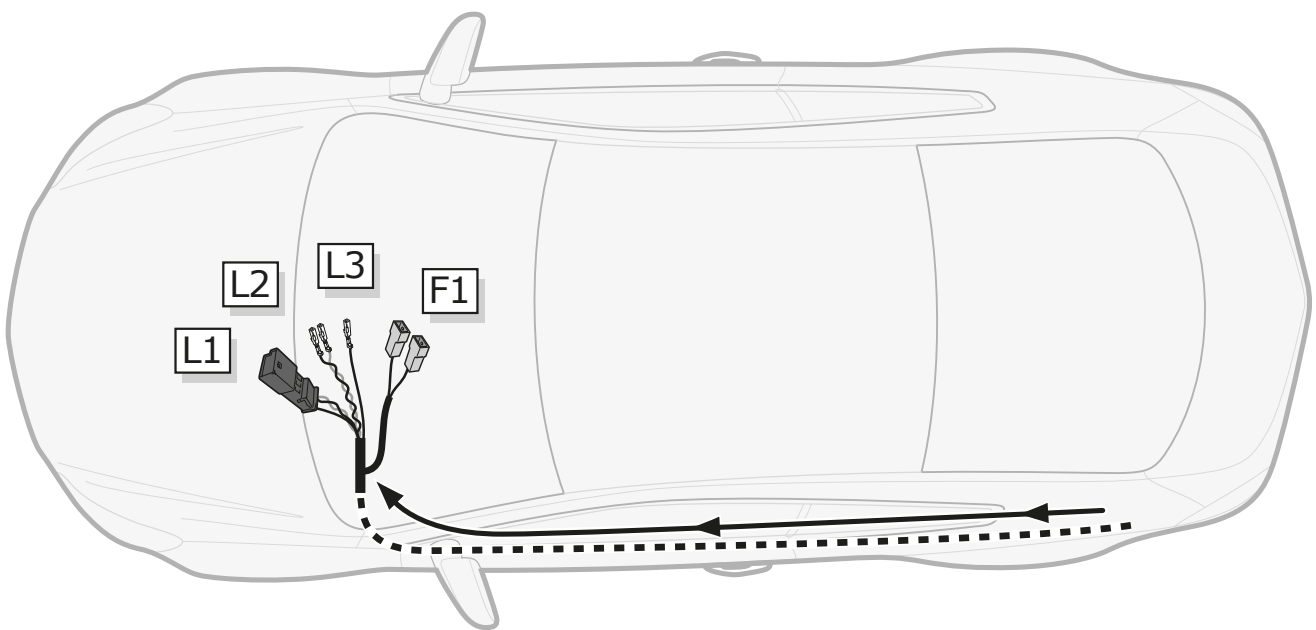

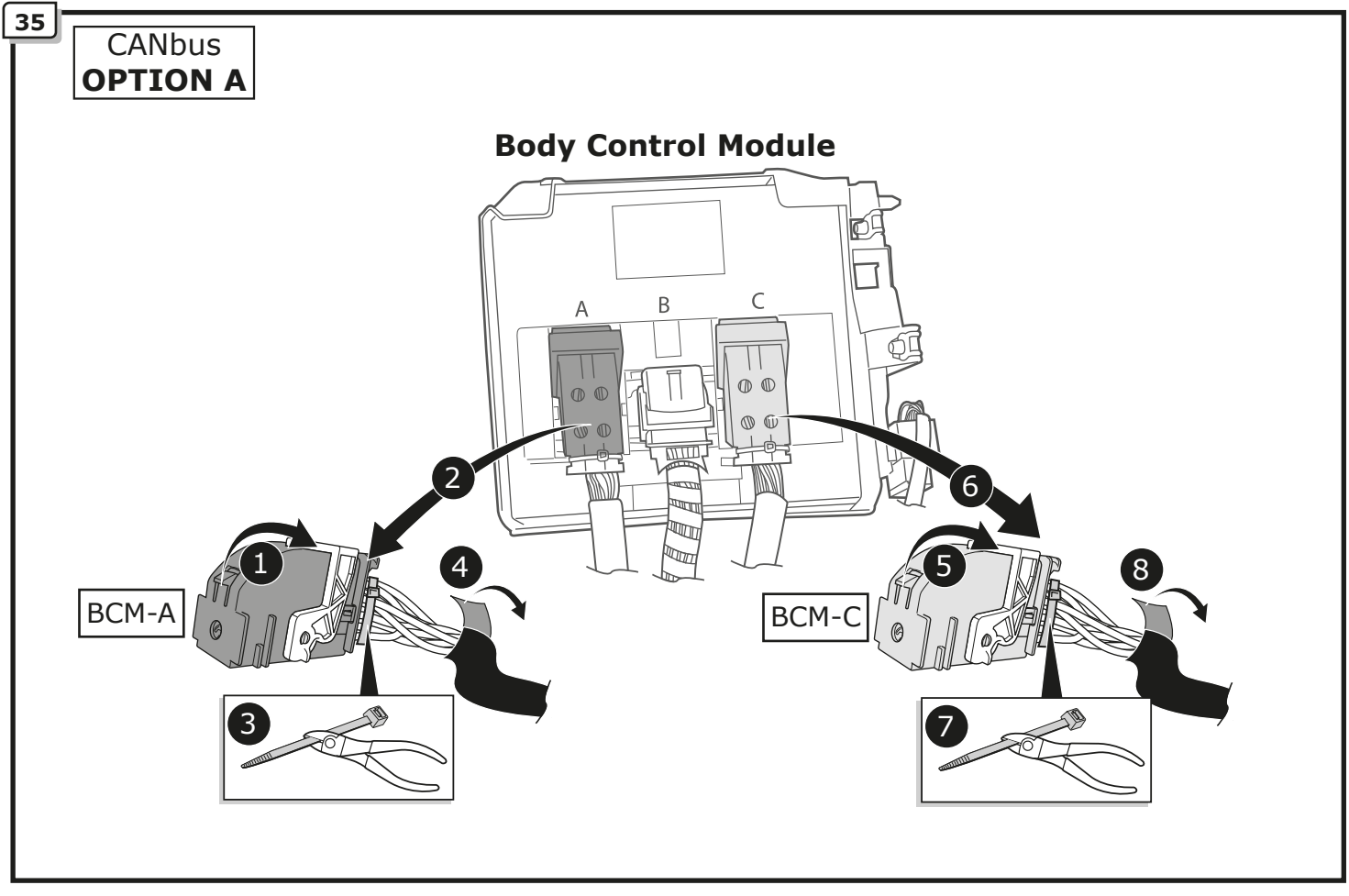
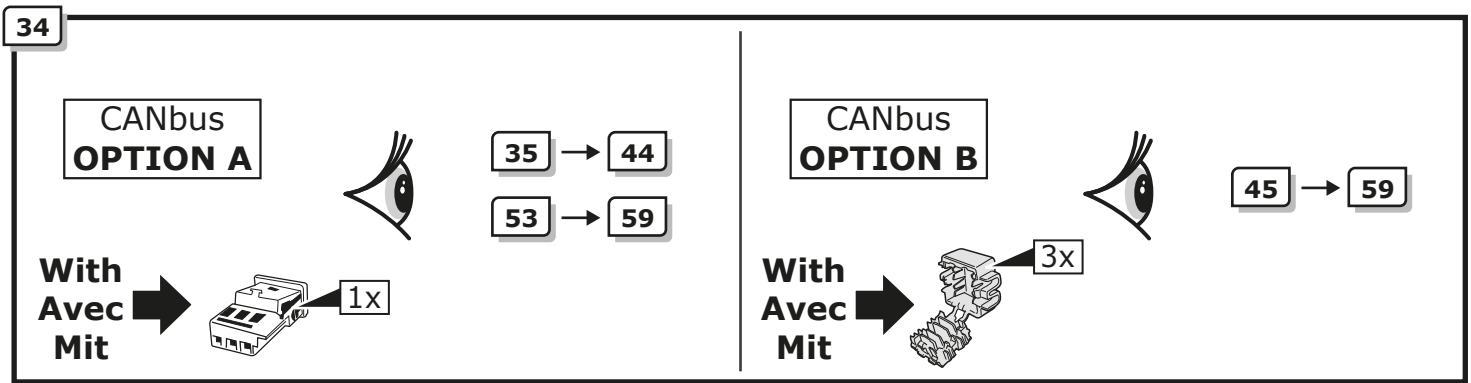
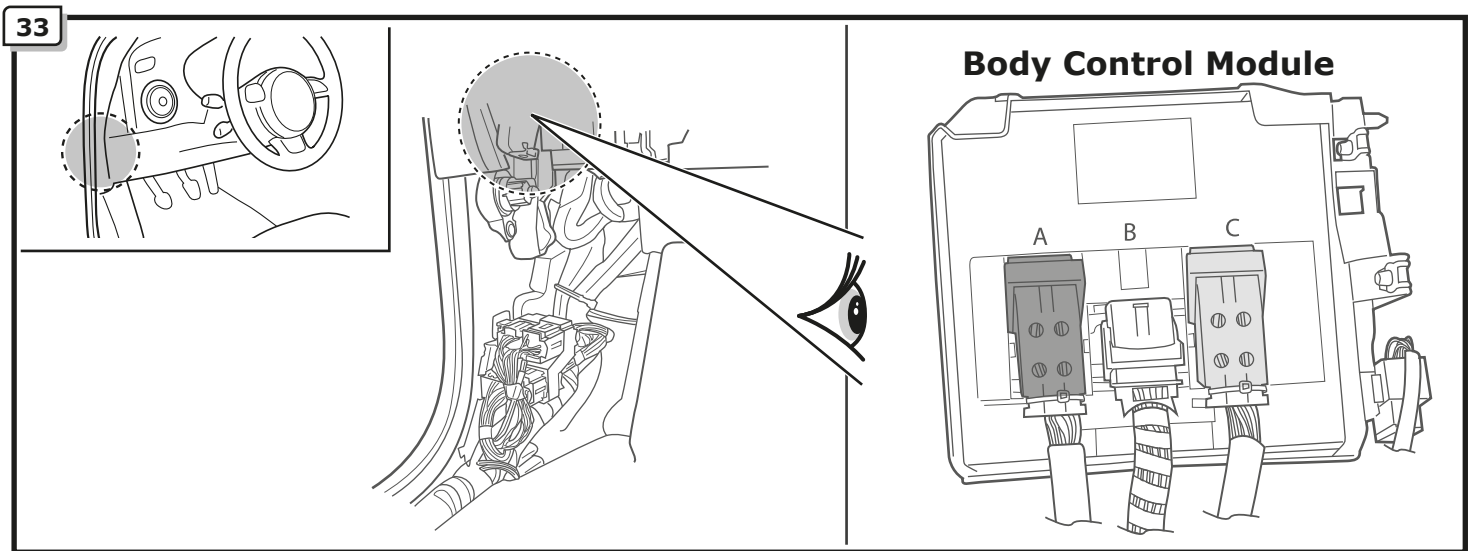

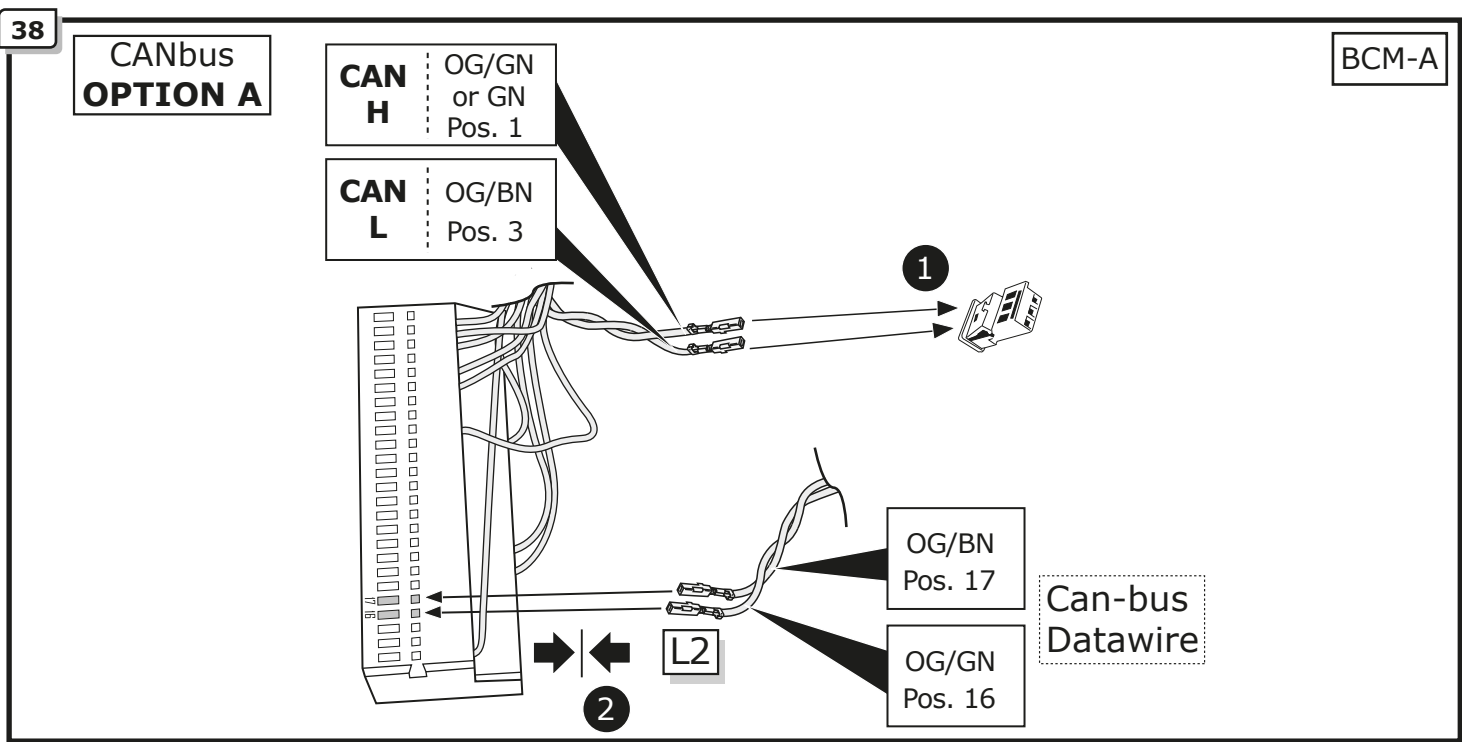
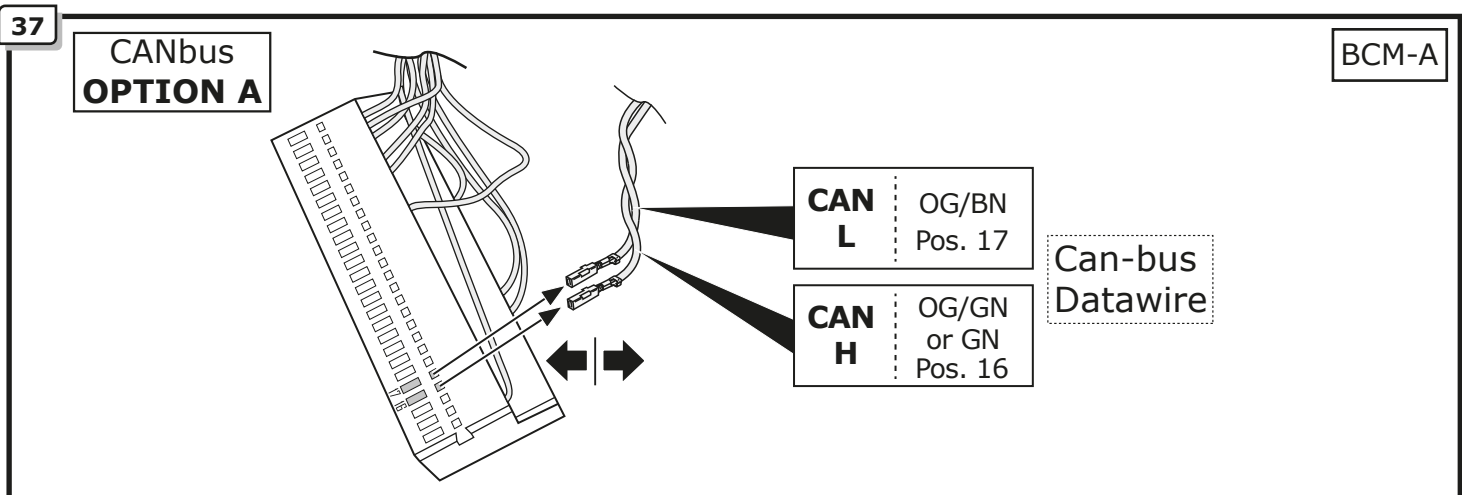
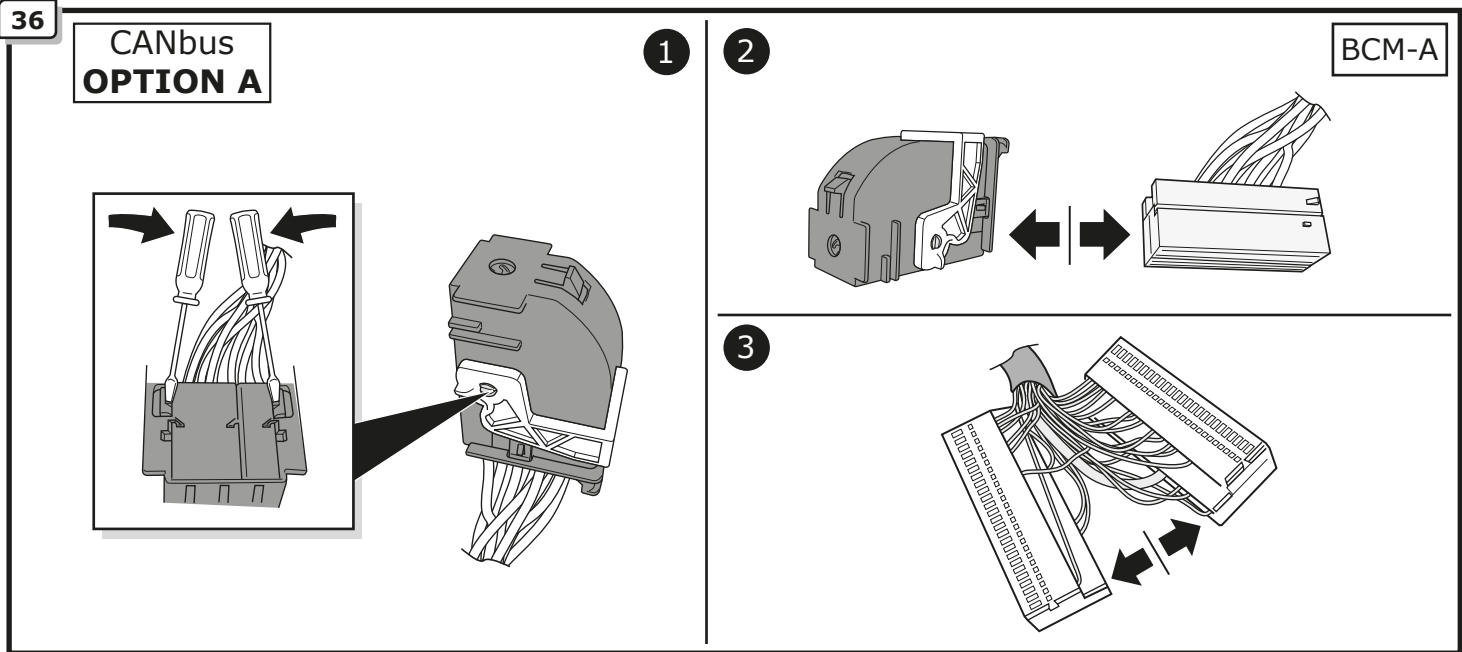

39

CANbus
OPTION A

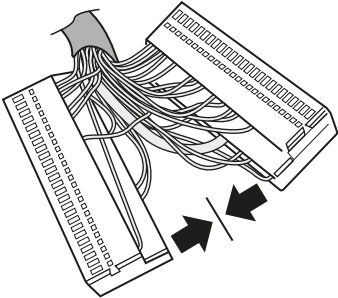

1

BCM-A

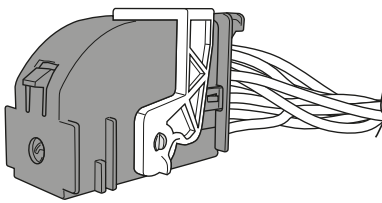

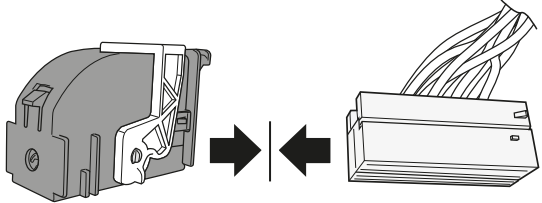

2

40

CANbus
OPTION A

BCM-C

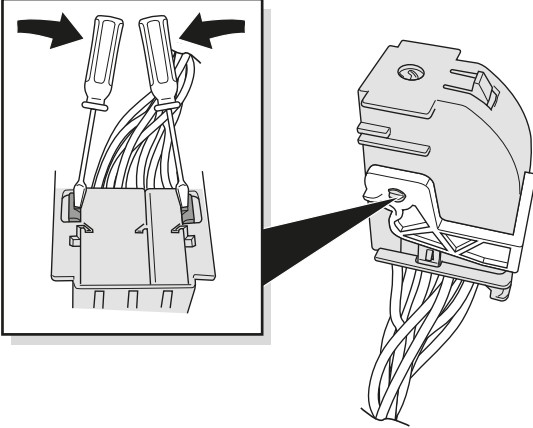

1

2

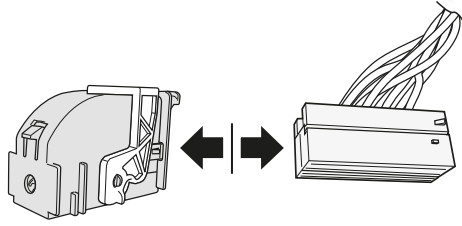

3

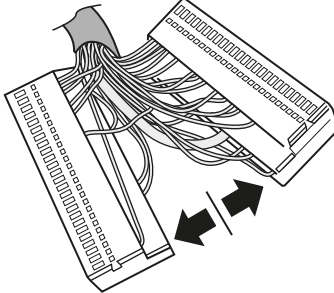

41

CANbus
OPTION A

BCM-C

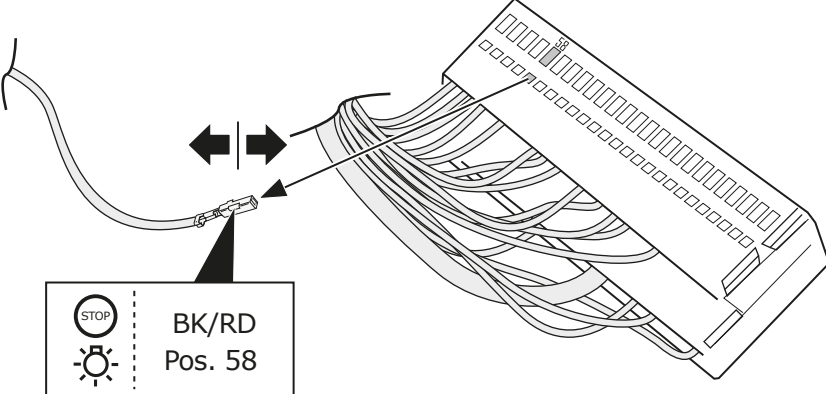

STOP BK/RD
☀ Pos. 58

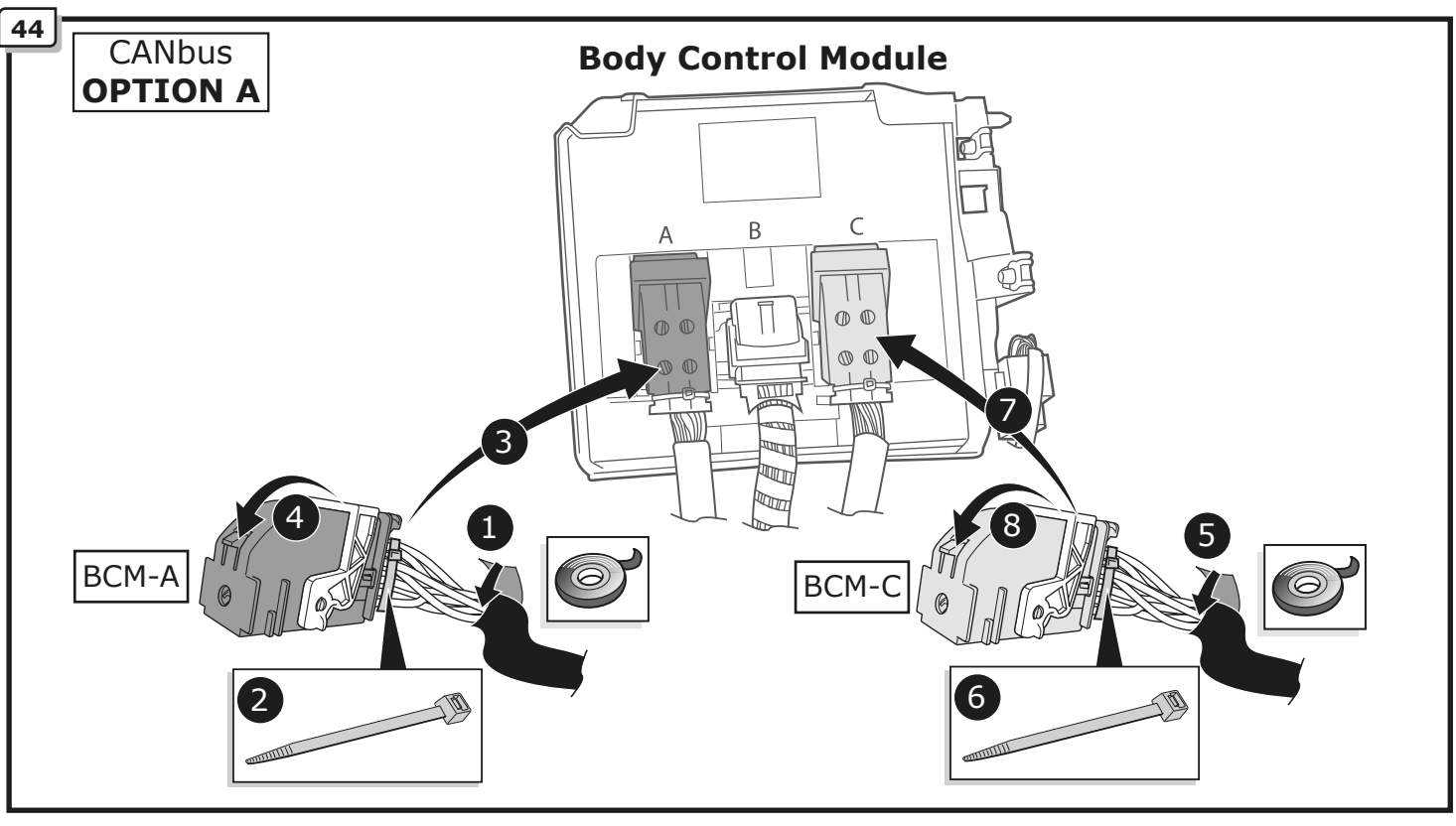
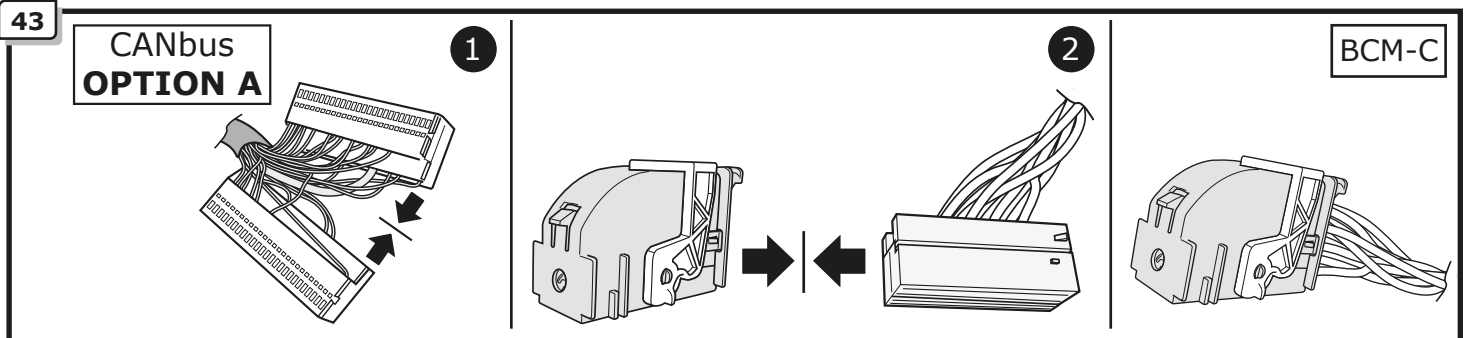
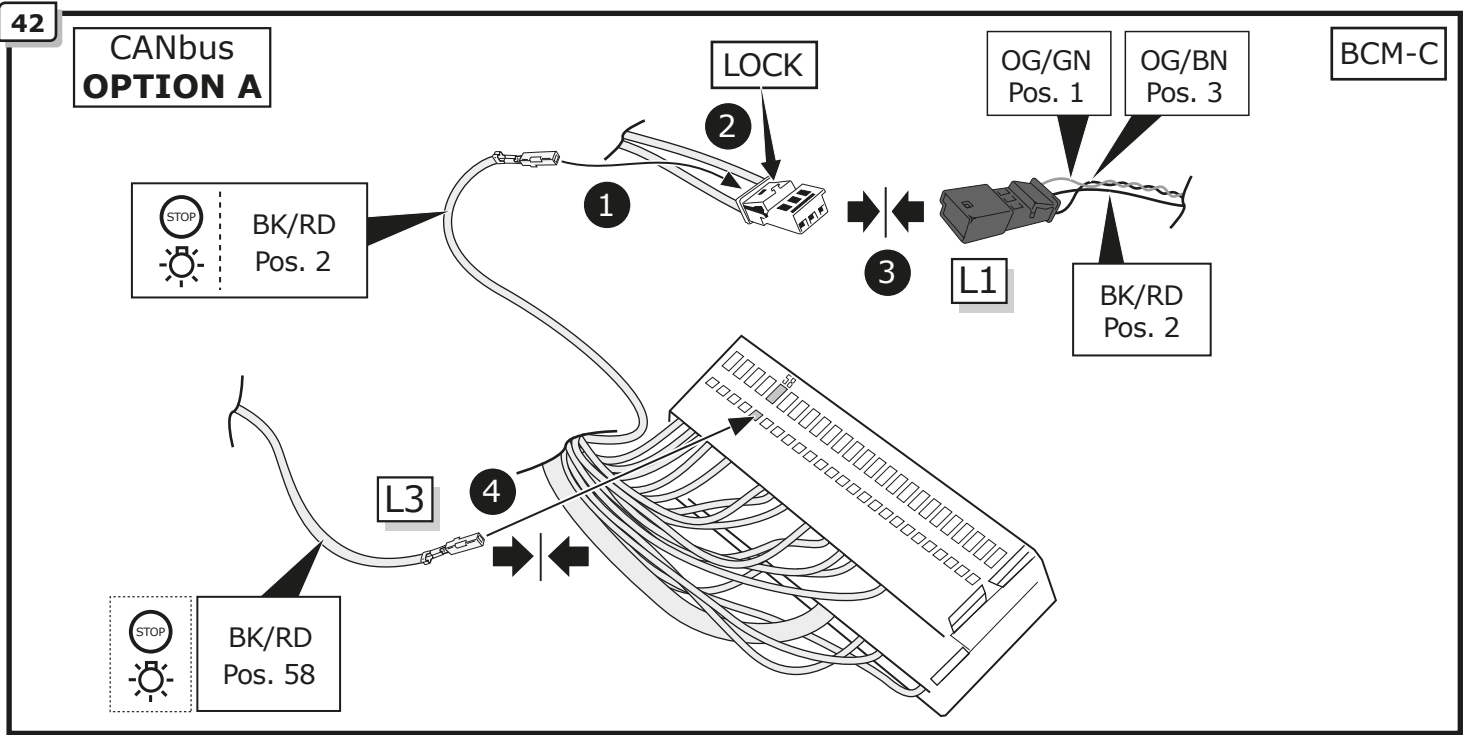

45

CANbus
OPTION B

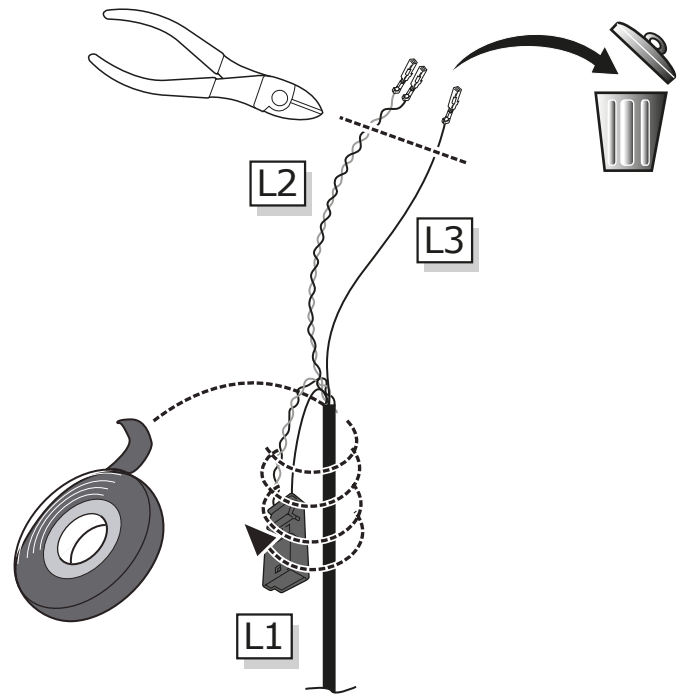

46

CANbus
OPTION B

Body Control Module

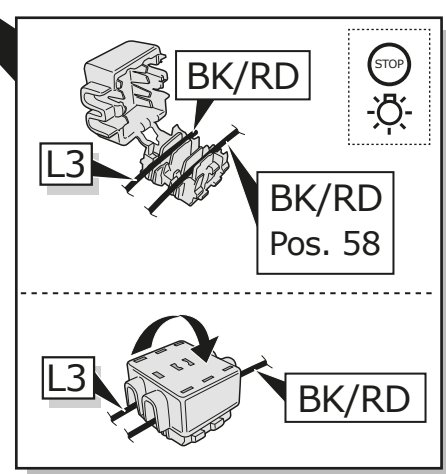
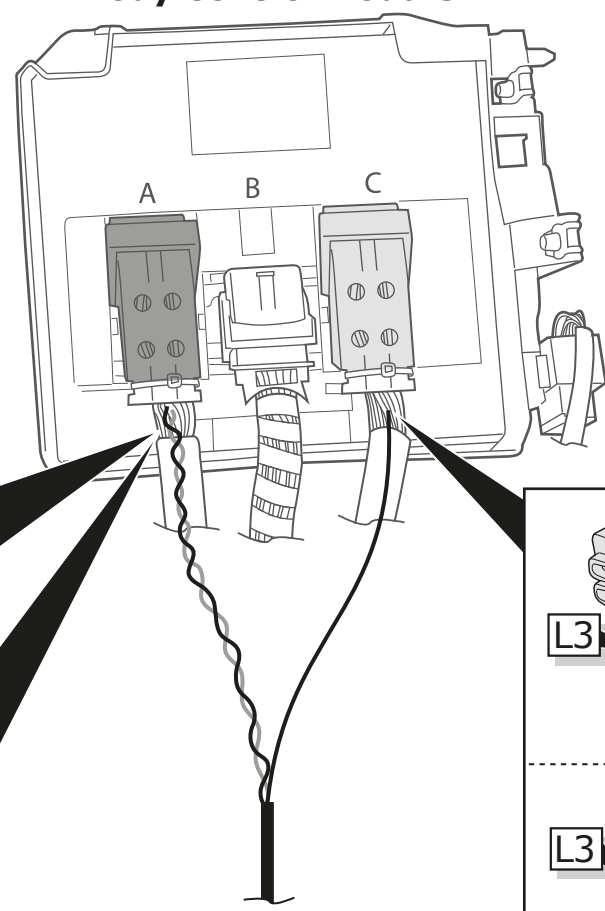
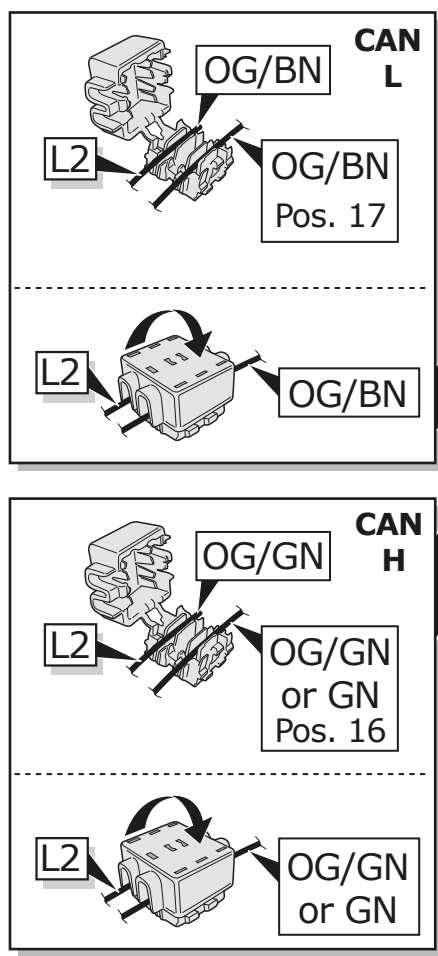

47

B+/30
OPTION A

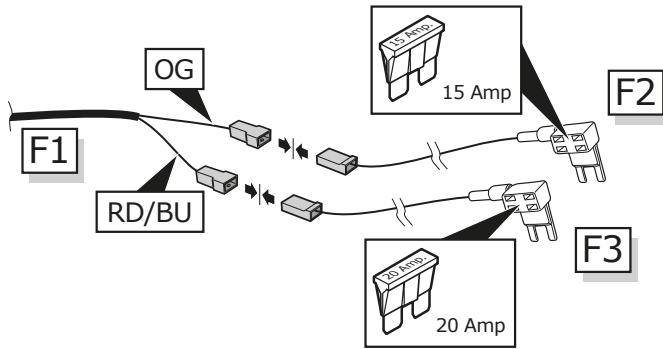

48

53 → 59

B+/30
OPTION B



49 → 59

48

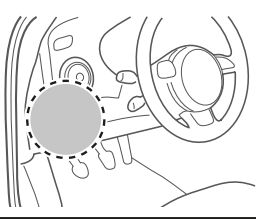

B+/30
OPTION A

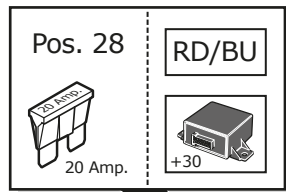

F1

F2

F3

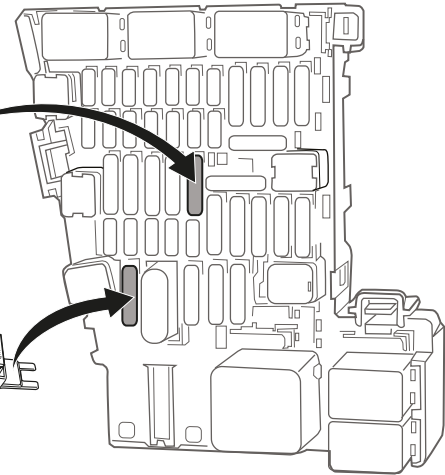

Pos. 44

OG

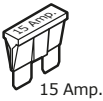

If pos. 44 is not useable:
Use an unoccupied B+/30 pos.

Wenn Pos. 44 nicht benutzt werden kann:
Benutze eine freie B+/30 pos.

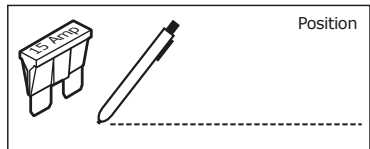

Position

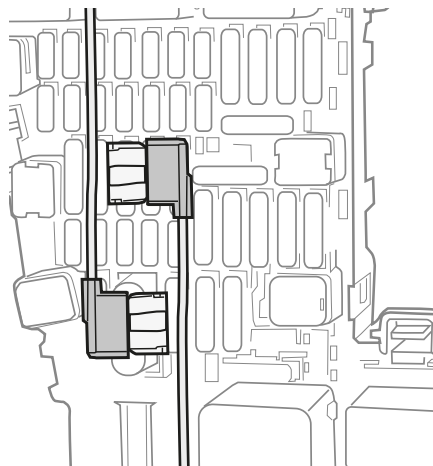

Important!
Please do not mount the fuse tap and its wiring output in the other direction!

Wichtig!
Die Sicherungsbrücke darf nicht in entgegengesetzter Richtung eingebaut werden!

49

B+/30
OPTION B

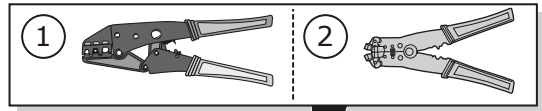
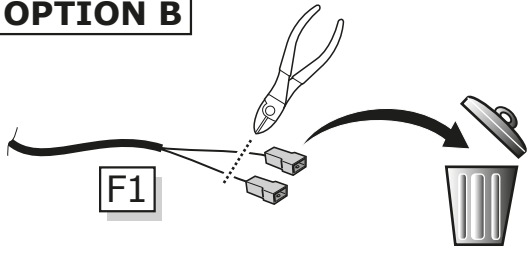

50

B+/30
OPTION B

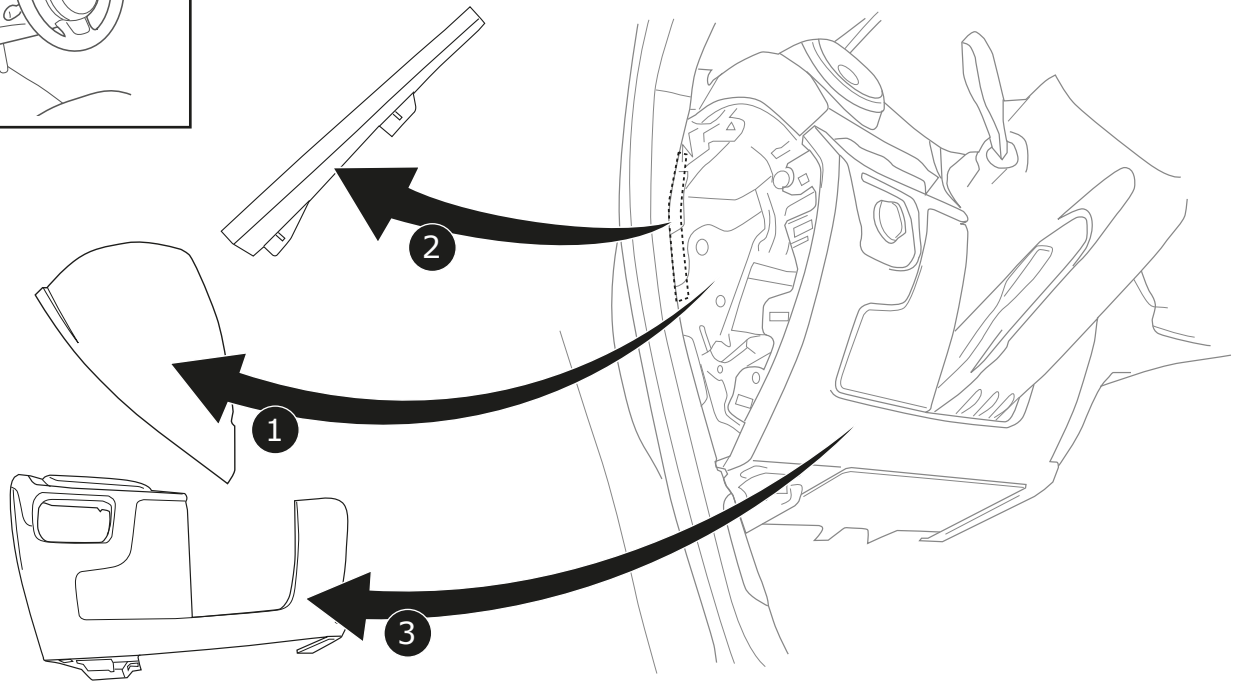
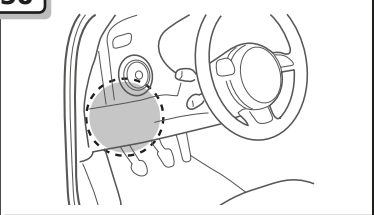

51

B+/30
OPTION B

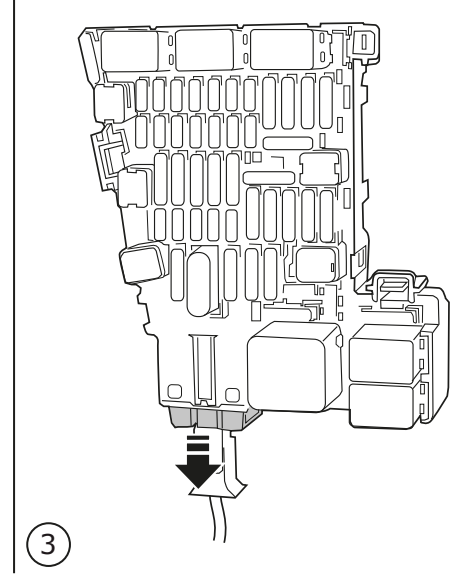
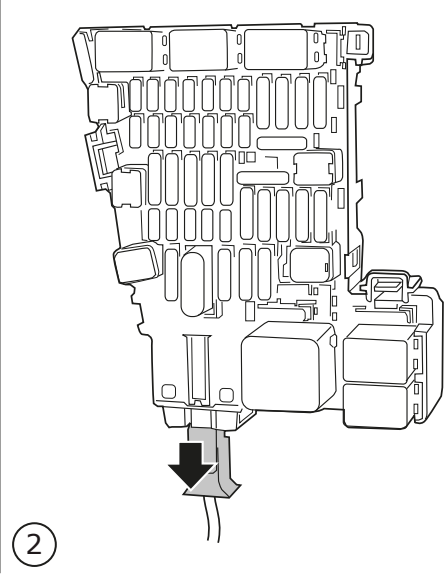
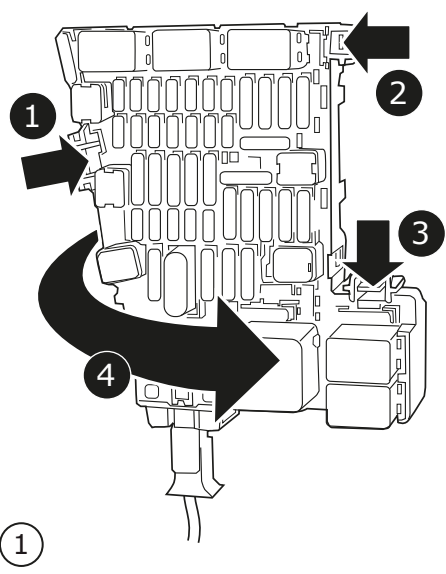

52

**B+/30
OPTION B**

Pos. 28



20 Amp.

RD/BU



+30

Pos. 44



15 Amp.

OG



+30

If pos. 44 is not useable:
Use pos. 38

Wenn Pos. 44 nicht benutzt werden kann:
Benutze pos. 38

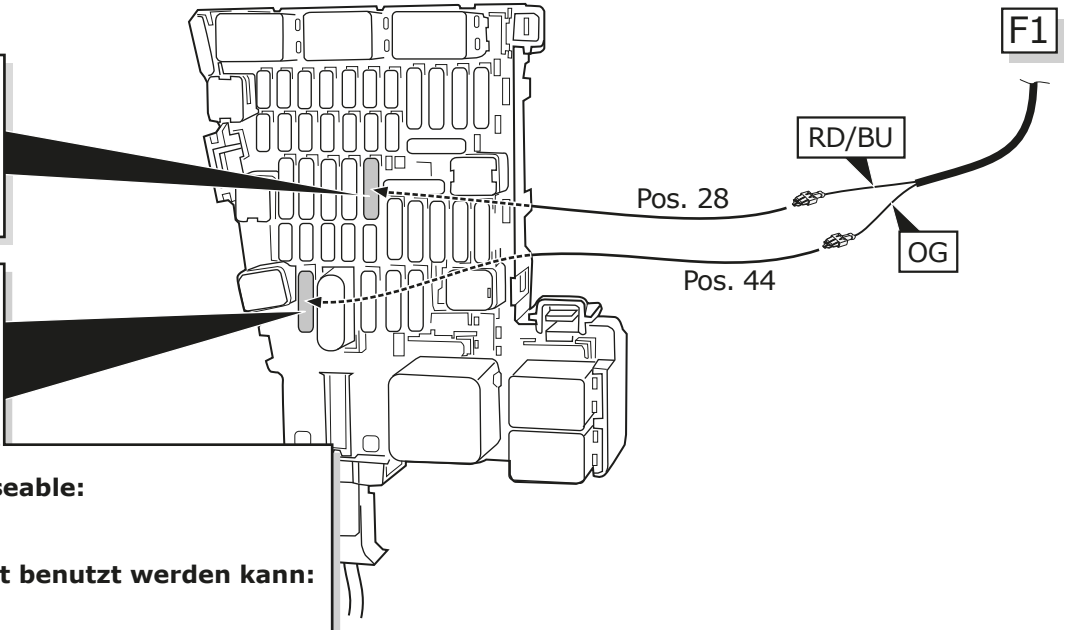

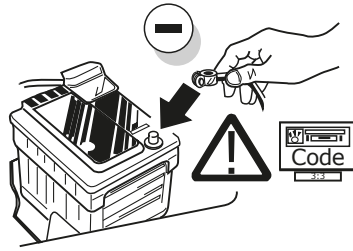

INFO



(DE)

(GB)

(FR)

**Diagnosedienstleister und Diagnose-
methode (lokal offline):**

Bitte beachten:

Immer die aktuellste Diagnoseversion verwenden. Das zu codierende Fahrzeug muss vom Diagnosedienstleister unterstützt werden und bereits in dessen Diagnoseversion implementiert sein. Bitte wenden Sie sich bei Fragen direkt an Ihren Diagnosedienstleister.

ACHTUNG!

Fahrzeuge ab Modelljahr 2021 sind mit einem sog. Schutz der Fahrzeugdiagnose (SFD) ausgestattet. Der Zugriff auf gesicherte Bordnetzsteuergeräte muss durch das Diagnosesystem gewährleistet sein. Mögliche Diagnosedienstleister:

- ODIS (Seite 25-26)
- JIFELINE

**Diagnostic services and methods
(local offline):**

Please note:

Always use the latest diagnostic version. The vehicle to be coded must be supported by the diagnostic service provider and already be implemented in the diagnostic version. Please contact your diagnostic service provider in case of any question.

ATTENTION!

Model year 2021 vehicles are equipped with a so-called vehicle diagnosis protection (SFD). Make sure that access to locked on-board control units is granted by the diagnostic system. Possible diagnostic service providers:

- ODIS (page 25-26)
- JIFELINE

**Services et méthodes
(Local hors ligne) :**

Veillez noter :

Utiliser toujours la dernière version de logiciel de votre appareil de diagnostic. Le véhicule à coder doit être prise en charge par le fournisseur de services de diagnostic et déjà implémenté dans la version de diagnostic ! Veuillez contacter votre fournisseur de services de diagnostic pour toutes questions.

ATTENTION :

Les véhicules de l'année modèle 2021 sont équipés d'une soit disant " Protection de Diagnostic Véhicule SFD " Assurer-vous que l'accès de l'ordinateur de bord du véhicule soit accordé par le système de diagnostic. Possibilité Equipements/ Fournisseurs :

- ODIS (page 25-26)
- JIFELINE

(IT)

(ES)

(NL)

**Apparecchiature e metodi di diagnosi
(offline) :**

Da notare:

Usare sempre la versione software più recente. Il veicolo da codificare deve essere supportato dalle attrezzature della diagnosi. In caso di domande, si prega di contattare il proprio fornitore di apparecchiature diagnostiche.

ATTENZIONE!

I modelli dell'anno 2021 sono dotati di un cosiddetto veicolo protezione crittografica (SFD). Assicurarsi in caso la rete di bordo sia scollegata per codificare / adattare le centraline. Possibili fornitori di attrezzature / servizi:

- ODIS (pagina 25-26)
- JIFELINE

**Sistemas y métodos de diagnóstico
(local sin conexión)**

Rogamos que presten atención a lo siguiente:

Utilice siempre la última versión de software. El vehículo que vayan a codificar debe de estar respaldado por el sistema de diagnóstico. Contacte con su proveedor de sistemas diagnósticos en caso que tengan preguntas.

ATENCIÓN

Vehículos con fecha de fabricación del 2021 están equipados con un llamado cifrado y protección (SFD). Asegúrese que la red de a bordo esté desconectada para codificar / adaptar las unidades de control. Los posibles proveedores de sistemas y servicios de diagnóstico son:

- ODIS (página 25-26)
- JIFELINE

**Diagnose apparatuur en methoden
(lokaal offline)**

Let op a.u.b.:

Gebruik altijd de nieuwste software versie. Het te coderen voertuig moet worden ondersteund door de diagnose apparatuur. Neem contact op met uw leverancier van de diagnose apparatuur in het geval van vragen.

AANDACHT!

Voertuigen vanaf modeljaar 2021 zijn uitgerust met een zogenaamd voertuig codeerbescherming (SFD). Zorg ervoor dat het boordnet is vrijgeschakeld om de regeleenheden te coderen/ aanpassen. Mogelijke apparatuur/ dienstverleners:

- ODIS (pagina 25-26)
- JIFELINE

INFO

- (DE) Achtung! Es ist sicherzustellen dass alle Anforderungen des Fahrzeugherstellers zu Änderungen und Nachrüstungen am Fahrzeug und/oder Kühlsystem für den Betrieb mit Anhänger durchgeführt wurden. Änderungen vorbehalten.
- (FR) Attention! Il convient de s'assurer que toutes les consignes imposées du fabricant du véhicule ont été respectées concernant les modifications et les équipements ultérieurs réalisés sur le véhicule et/ou le système de refroidissement pour l'utilisation avec la remorque. Sous réserve de modifications.
- (NL) Opgelet! Zorg ervoor dat voor de werking met aanhangwagen aan alle eisen van de voertuigfabrikant ivm veranderingen en wijzigingen aan het voertuig en/of koelsysteem werd voldaan. Wijzigingen voorbehouden.
- (GB) Warning! It must be ensured that all the requirements of the vehicle manufacturer for changes to and retro-fitting on the vehicle and/or cooling system for the operation with a trailer are carried out. Subject to change.
- (ES) ¡Atención! Se debe asegurar que se ha cumplido con todos los requerimientos del fabricante del vehículo en lo que respecta a modificaciones y reequipamiento en el vehículo y/o sistema de refrigeración para la operación con remolque. Nos reservamos el derecho a efectuar modificaciones.
- (IT) Attenzione! Occorre controllare che vengano rispettati tutti i requisiti del costruttore del veicolo relativi alle modifiche e agli accessori sul veicolo e/o sull'impianto del raffreddamento per l'esercizio del rimorchio. Con riserva di modifiche.
- (SE) Observera! Det skall säkerställas att samtliga krav från fordonstillverkaren gällande ändringar på och kompletteringsutrustning av fordonet och/eller kylsystemet för användning med släp har genomförts. Ändringar förbehålls.
- (CZ) Pozor! Ujistěte se, zda jsou splněny všechny podmínky provozu přívěsu stanovené výrobcem vozidla a zda byly provedeny všechny úpravy a dodatečné vybavení vozidla či chladicího systému. Změny vyhrazeny.
- (DK) OBS! Kontrollér, at alle køretøjsproducentens krav til ændringer og eftermonteringer på køretøj og/eller kølesystem til brug med anhænger er blevet gennemført. Ret til ændringer forbeholdes.
- (FI) Huomio! On varmistettava, että kaikkia ajoneuvon valmistajan ajoneuvoon ja/tai jäähdytysjärjestelmään tehtäviin muutoksiin ja jälkivarusteluihin, jotka koskevat perävaunun käyttöä, liittyviä vaatimuksia noudatetaan. Oikeudet muutoksiin pidätetään.
- (GR) Προσοχή! Θα πρέπει να διασφαλιστεί ότι έχουν υλοποιηθεί όλες οι απαιτήσεις του κατασκευαστή του οχήματος για μετατροπές και προσθήκες εξοπλισμού στο όχημα ή/και το σύστημα ψύξης, οι οποίες σχετίζονται με τη λειτουργία με ρυμουλκούμενο. Διατηρούμε το δικαίωμα αλλαγών.
- (NO) Obs! Man må forsikre seg om at alle kravene til kjøretøyprodusenten vedrørende endringer og etterutrustninger på kjøretøyet og/eller kjølesystemet ble gjennomført for drift med tilhenger. Med forbehold om endringer.
- (PL) Uwaga! Należy się upewnić, że zostały spełnione wszystkie wymagania producenta pojazdu dotyczące zmian i doposażenia pojazdu i/lub systemu chłodzenia w celu eksploatacji z przyczepą. Zmiany zastrzeżone.



CODIERUNG MIT ODIS

Bitte beachten:

Der nachfolgend beschriebene Ablauf zur Codierung bzw. Freischaltung auf Anhängerbetrieb dient lediglich zur allgemeinen Orientierung und kann je nach Modell (Motorisierung / Ausstattung) stark variieren. Gegebenenfalls müssen weniger oder noch weitere Steuergeräte angepasst werden.

Nach dem Verbinden mit ODIS muss in der Sollverbauiste das Steuergerät "69 Anhängerfunktion" auf codiert gesetzt werden.

Im weiteren Verlauf ggf. erforderlich Codierungen:

EZE_09 (Elektronisches Zentralelektrik-Steuergerät):

Diagnose / Eigendiagnose
(möglicher Login Code: 31347)
Vernetzungsplan
Eigendiagnose Steuergerät
Codieren
Anhängerschlossgerät >verbaut
oder: hitch_ecu >installed

Alternative Codierung EZE_09

wie folgt (MJ 2017 >>):

Eigendiagnose Steuergerät
Zugriffsberechtigung >31347
Anpassung
Vernetzung
Anhängerschlossgerät > verbaut

ZKS_46 (Zentralmodul Komfortsystem)

trailer monitoring >auf aktiv setzen
trailer control unit >verbaut

SWA_3C (Spurwechselassistent)

ECU for draw bar >with ECU for draw bar

SW2_CF (Spurwechselassistent2)

ECU for draw bar >with ECU for draw bar

SCH_17 (Schalttafeleinsatz)

Trailer >ja

RFK_6C (Rückfahrkamerasystem)

equipment_ahk >verbaut

STF_74 (Fahrwerkssteuerung)

Anhänger >verbaut

EPH_76 (Einparkhilfe Steuergerät)

Anhänger >Anhängervorrichtung

DIS_13 (Distanzregelung Steuergerät)

(möglicher Login Code: 20103)
Controlmodule for towing sens >verbaut

Alternative Codierung DIS_13 wie folgt:

Eigendiagnose Steuergerät
Zugriffsberechtigung >20103
Codieren
Binary Codierung
Byte 3
Binär >xxxx1xxx
oder Hex >+8

03 Bremselektronik

Zugangsberechtigung > 61378
Anpassungen
Anhängerstabilität > Aktiv

FFF_A5 (Frontsensorik Steuergerät)

AAG >coded

HDE_6D (Heckdeckelelektronik Steuergerät)

Anhänger >verbaut

Wichtiger Hinweis zu Codierung

bzw. Freischaltung auf Anhängerbetrieb

Die vorab genannten Einstellungen werden im Bordnetz des Fahrzeuges vorgenommen und lokal abgespeichert. Bei generellen Updates der Fahrzeugsoftware (beispielsweise im Rahmen von Service- oder Instandsetzungsarbeiten), können diese Einstellungen unter Umständen wieder überschrieben und gelöscht werden. In diesem Fall muss die Freischaltung auf Anhängerbetrieb nach dem Update noch einmal lokal aktualisiert werden. Diagnosehinweise in Bezug auf Anhängerbetrieb, die bei Soll-/Ist-Vergleichen mit den im Herstellerwerk hinterlegten Daten auftreten können, liegen ggf. der lokalen Freischaltung zu Grunde.

CODING WITH ODIS

Please note:

The procedure described below for encoding and enabling the trailer mode only serves for a general orientation and can vary greatly depending on the model (motorisation / equipment). If necessary less or further control units will have to be adapted.

After connecting to ODIS, the "69 trailer function" controller has to be set to encoded in the target installation list.

The following may be necessary in the further course of work:

EZE_09 (electronic central electric controller):

Diagnosis
(possible login code: 31347)
Networking plan
Controller self-diagnosis
Encode
Trailer connection device >installed
or: hitch_ecu >installed

Alternative encoding EZE_09

as follows (MY 2017 >>):

Self diagnose control unit
Access authorization >31347
Adjustment
Integration
Trailer control unit > installed

ZKS_46 (Central module convenience system)

trailer monitoring >put on active
trailer control unit >installed

SWA_3C (Lane Change Assist)

ECU for draw bar >with ECU for draw bar

SW2_CF (Lane Change Assist2)

ECU for draw bar >with ECU for draw bar

SCH_17 (Dash panel insert)

Trailer >yes

RFK_6C (reverse camera system)

equipment_ahk >installed

STF_74 (chassis control system)

Trailer >installed

EPH_76 (PDC controller)

Trailer >trailer device can be removed manually

DIS_13 (controller distance control

(possible login code: 20103)
Control module for towing sens >installed

Alternative encoding DIS_13 as follows:

Self diagnose control unit
Access authorization >20103
Encoding
Binary encoding
Byte 3
Binary >xxxx1xxx
or Hex >+8
03 Brake electronics
Access authorisation > 61378
Adjustments
Trailer stability >Active

FFF_A5 (front sensor system controller)

AAG >coded

HDE_6D (boot lid electronics controller)

Trailer >installed

Important note on encoding and activating in trailer mode

The aforementioned settings are carried out in the vehicle's electrical system and saved locally. During general updates for the vehicle software (for example, within the scope of service or repair work), the settings may be overwritten and deleted under certain circumstances. In this case, the trailer mode activation has to be updated again locally after the update. Diagnostic information relating to the trailer mode that may appear during variance comparisons with the data saved in the manufacturer's works, may form the basis of the local activation.

CODAGE AVEC ODIS

Attention:

La procédure de codage ou d'activation du fonctionnement avec remorque décrite cidessous sert uniquement d'orientation générale et peut varier fortement d'un modèle à l'autre (motorisation / équipement). Le cas échéant, il peut s'avérer nécessaire d'adapter moins ou d'autres dispositifs de commande.

Une fois la connexion avec ODIS établie, mettre l'appareil de commande "69 fonctionnement avec remorque" sur codé dans la liste d'assemblage théorique.

Éventuellement nécessaire dans la suite du déroulement:

EZE_09 (appareil de commande de la centrale électrique électronique):

Diagnostic
(possibilité de codage: 31347)
Plan de mise en réseau
Autodiagnostic appareil de commande
Codage
Appareil de connexion de la remorque >monté
ou: hitch_ecu >monté

Ensuite Codage alternatif EZE_09 (MJ 2017 >>):

Autodiagnostic boîtier de commande
Autorisation d'accès >31347
Ajustement
Intégration
L'unité de remorque > installée

ZKS_46 (Système de commodité de module Central)

trailer monitoring >mettre actif
trailer control unit >monté

SWA_3C (l'aide au changement de voie)

ECU for draw bar >with ECU for draw bar

SW2_CF (l'aide au changement de voie2)

ECU for draw bar >with ECU for draw bar

SCH_17 (tableau de commande insert)

Remorque >oui

RFK_6C (Système de caméra de recul)

equipment_ahk >monté

STF_74 (Système de commande de châssis)

Anhänger >monté

EPH_76 (aide au stationnement appareil de commande)

Remorque >dispositif de remorque
>démontable à la main

DIS_13 (régulateur de distance appareil de commande)

(possibilité de codage: 20103)
Control module for towing sens >monté

Ensuite Codage alternatif DIS_13

Autodiagnostic boîtier de commande
Autorisation d'accès >20103
Codage Binaire
Binaire codage
Byte 3
Binary >xxxx1xxx
ou Hex >+8

03 Système de Freinage

Autorisation d'accès > 61378
Ajustements
Stabilité de la remorque > Actif

FFF_A5 (capteurs avant appareil de commande)

AAG >coded

HDE-6D (appareil de commande de l'électronique du hayon électrique)

Remorque >monté

Remarque importante sur le codage ou sur l'activation du fonctionnement avec remorque. Les réglages mentionnés ci-dessus sont effectués dans le réseau de bord du véhicule et sauvegardés localement. Lors des mises à jour générales du logiciel du véhicule (par exemple dans le cadre de travaux de maintenance ou de réparation), ces réglages peuvent dans certaines circonstances être écrasés et supprimés. Dans ce cas, l'activation du fonctionnement avec remorque doit être à nouveau actualisée localement après la mise à jour. L'activation locale peut le cas échéant être causées par des remarques de diagnostic relatives au fonctionnement avec remorque susceptibles d'être générées lors de la comparaison entre valeurs théoriques/valeurs réelles effectuée avec les valeurs conservées dans l'usine du constructeur.

54

Functional test

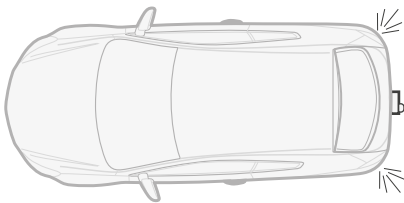
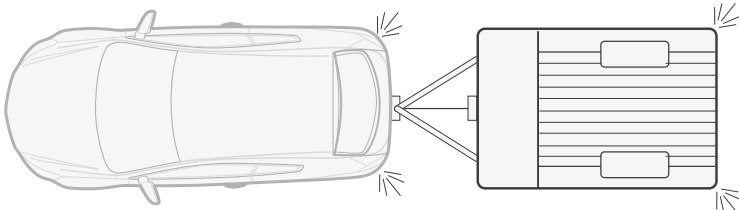
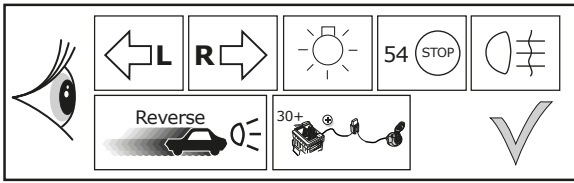

LIGHTMATE

ECS part no.
LIGHTMATE II
LIGHTMATE III

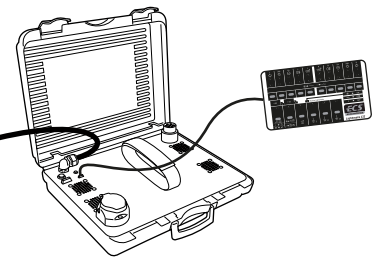

55

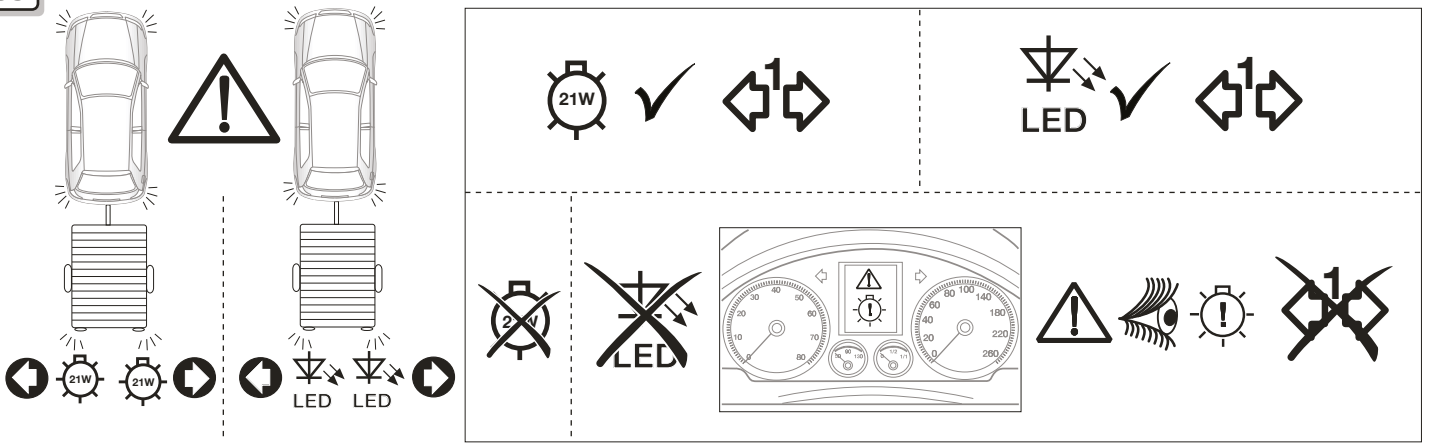

56

Optional

Adapter socket

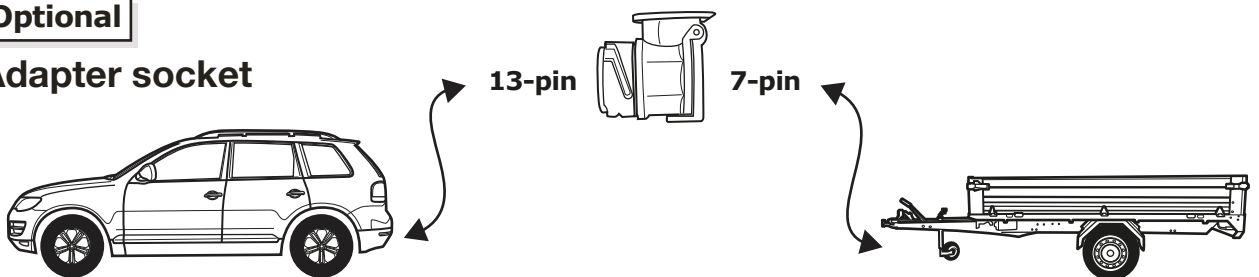

57

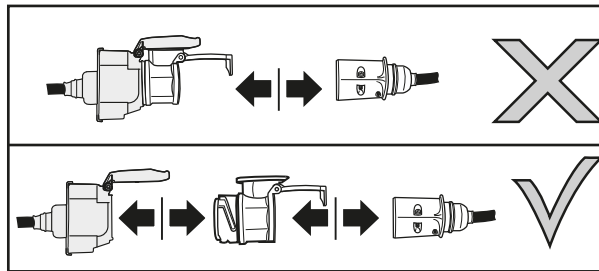
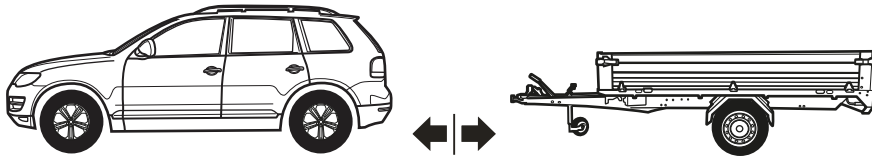

Products & Service: <https://www.ecs-electronics.nl/test-equipment>

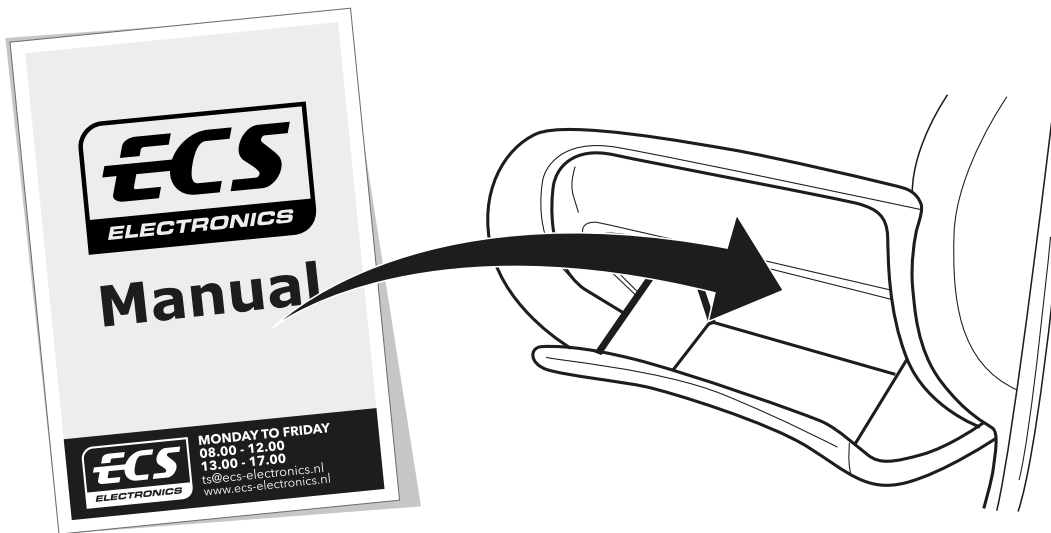
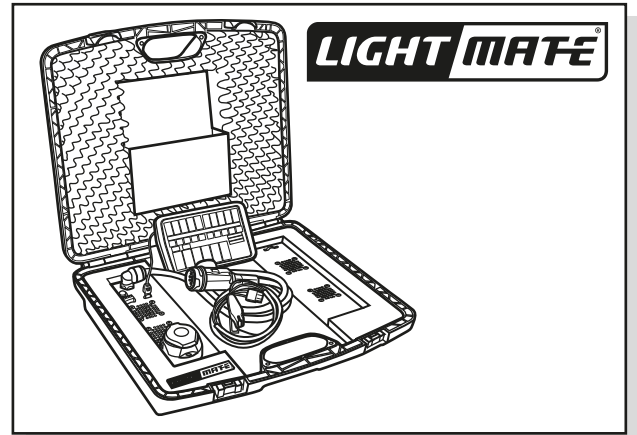
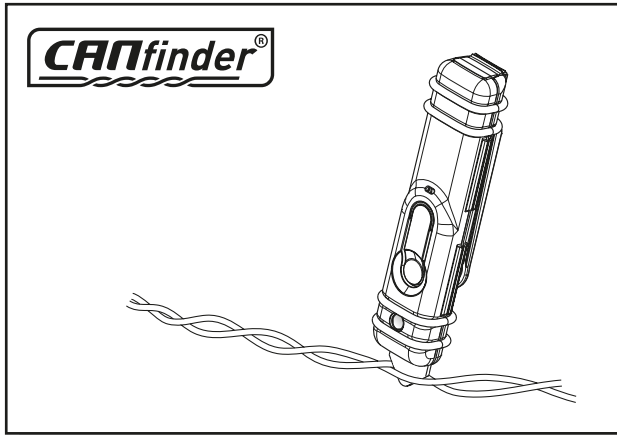

**FITTERS
TECHNICAL
SUPPORT**



**MONDAY TO FRIDAY
08.00 - 12.00
13.00 - 17.00**

ts@ecs-electronics.nl
www.ecs-electronics.nl
tel: +31 (0)76 573 0020

INFO

- (DE) Anschluss Steckdose (ES) Conexión de la caja de enchufe (CZ) Objímkový konektor (GR) Υποδοχή σύνδεσης
- (FR) Connection de la prise (IT) Allaccio zoccolo (DK) Stikdåse forbindelse (NO) Tilkobling koblingsboks
- (NL) Contactdoos aansluiting (SE) Anslutning kontaktdosa (FI) Pistorasia liitäntä (PL) Połączenie przez gniazdo
- (GB) Socket connection

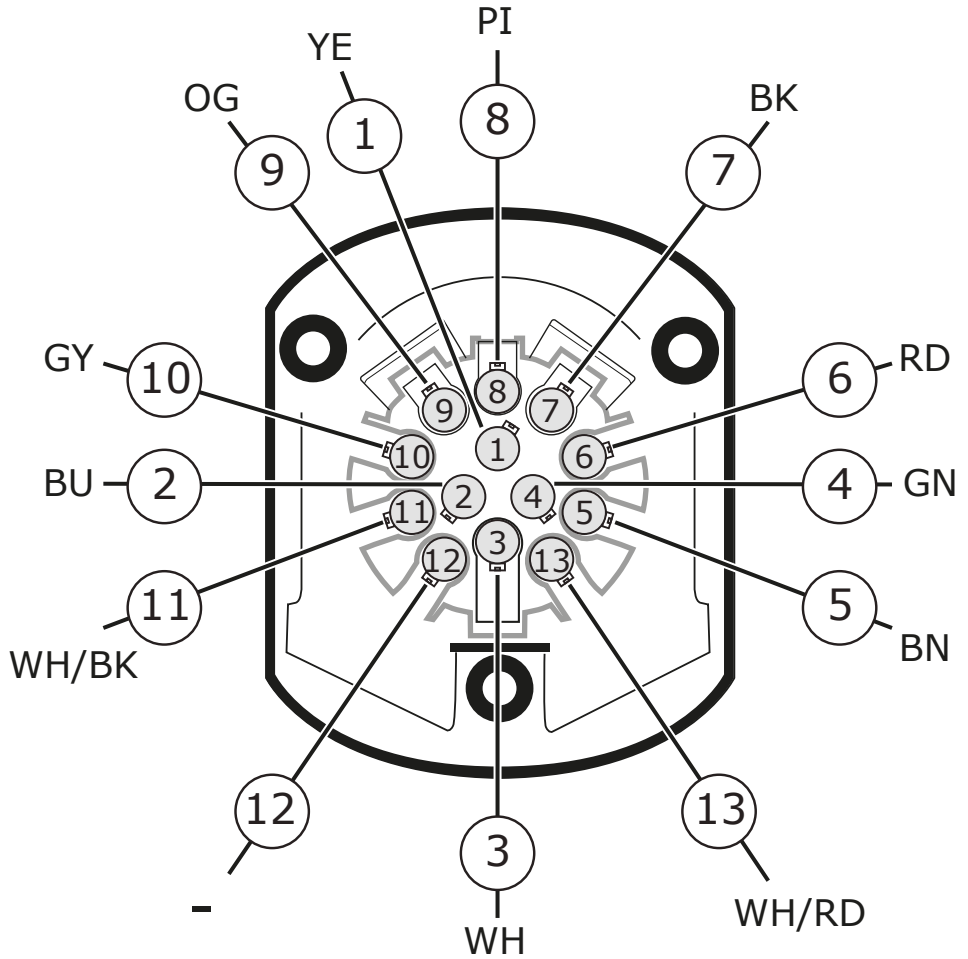
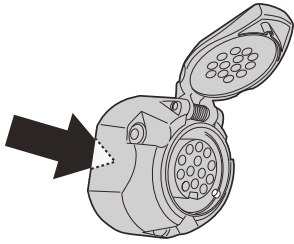

- (DE) Anschluss Steckdose (ES) Conexión de la caja de enchufe (CZ) Objímkový konektor (GR) Υποδοχή σύνδεσης
- (FR) Connection de la prise (IT) Allaccio zoccolo (DK) Stikdåse forbindelse (NO) Tilkobling koblingsboks
- (NL) Contactdoos aansluiting (SE) Anslutning kontaktdosa (FI) Pistorasia liitäntä (PL) Połączenie przez gniazdo
- (GB) Socket connection

DIN/ISO 11446													
Pmax	21W	21W		21W	42W	3x21W	42W	21W	OPTION	OPTION			
	YE	BU	WH	GN	BN	RD	BK	PI	OG	GY	WH/BK	-	WH/RD

COLORTABLE

	BK	BN	BU	GY	GN	WH	YE	OG	PE	PI	RD
(DE)	Schwarz	Braun	Blau	Grau	Grün	Weiß	Gelb	Orange	Violett	Rosa	Rot
(FR)	Noir	Marron	Blue	Gris	Vert	Blanc	Jaune	Orange	Violet	Rose	Rouge
(NL)	Zwart	Bruin	Blauw	Grijs	Groen	Wit	Geel	Oranje	Paars	Roze	Rood
(GB)	Black	Brown	Blue	Grey	Green	White	Yellow	Orange	Purple	Pink	Red
(ES)	Negro	Marrón	Azul	Gris	Verde	Blanco	Amarillo	Naranja	Morado	Rosa	Rojo
(IT)	Nero	Marrone	Blu	Grigio	Verde	Bianco	Giallo	Arancione	Viola	Rosa	Rosso
(SE)	Svart	Brun	Blå	Grå	Grön	Vit	Gul	Orange	Lila	Rosa	Röd
(CZ)	Černá	Hnědá	Modrá	Šedá	Zelená	Bílá	Žlutá	Oranžová	Fialová	Růžová	Červená
(DK)	Sort	Brun	Blå	Grå	Grøn	Hvid	Gul	Orange	Lilla	Pink	Rød
(FI)	Musta	Ruskea	Sininen	Harmaa	Vihreä	Valkoinen	Keltainen	Oranssi	Purppura	Vaaleanpunainen	Punainen
(GR)	Μαύρο	Καφέ	Μπλε	Γκρι	Πράσινο	Λευκό	Κίτρινο	Πορτοκαλί	Μοβ	Ροζ	Κόκκινο
(NO)	Svart	Brun	Blå	Grå	Grønn	Hvit	Gul	Oransje	Lilla	Rosa	Rød
(PL)	Czarny	Brazowy	Niebieski	Szary	Zielony	Biały	Żółty	Pomarańczowy	Purpurowy	Różowy	Czerwony